

**P20E28****2,8m.****P20E57****5,7m.**

- Profilo fermavetro. Spessore 27x25mm. Per vetri 8÷13,52mm. Fissaggio pavimento e soffitto.
- Perfil refuerzo. 27x25mm de espesor. Vidrio de 8mm ÷ 13,52mm. Fijación al suelo y el techo.
- Profile for glass fixing. 27x25mm thickness. For 8÷13,52mm glass. Floor and ceiling mounting.
- Glasklemmprofil. Abmessungen B=27mm H=25mm. Für Boden- und Deckenbefestigung und Glasdicken 8-13,52mm.
- Profil de renfort. épaisseur 27x25mm. Pour verres 8÷13,52mm. Fixation au sol et fixation murale.

**Compresso / Included**

SPESSORE  
ESPOR  
THICKNESS  
DICKE  
ÉPAISSEUR

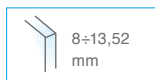
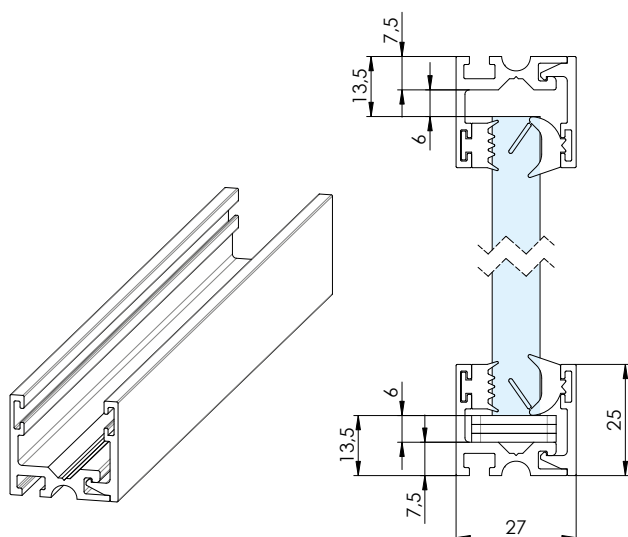
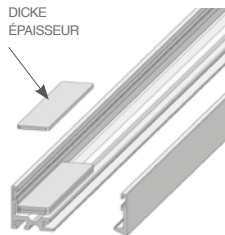

SPESSORI-ESPEORES  
THICKNESSES-DICKEN  
ÉPAISSEUR

Compressi nel kit n°6 pezzi ogni metro lineare di profilo  
El kit incluye n° 6 piezas de herraje cada metros lineales de perfil  
6 pieces per each profile meter are included in the set  
Im Set gibt es 6 Stück je Profilmeter  
6 pièces pour chaque mètre linéaire de profil sont comprises dans le kit

**Guarnizioni da ordinare in base allo spessore del vetro**  
**Gaskets to be purchased according to the glass thickness**

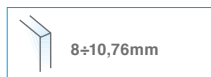
**P20EJ0810/6**

Coppia di guarnizioni L=6m.  
Pareja de guarniciones L=6m.  
Pair of gaskets L=6m.  
Paar Dichtungsbänder L=6m.  
Paire de garnitures L= 6 m.

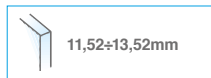
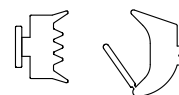
**P20EJ1113/6**

Coppia di guarnizioni L=6m.  
Pareja de guarniciones L=6m.  
Pair of gaskets L=6m.  
Paar Dichtungsbänder L=6m.  
Paire de garnitures L= 6 m.

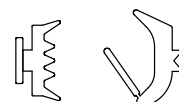
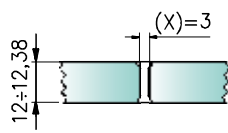
**Non compreso / Not included****PCC18**

Profilo in policarbonato  
Perfil en policarbonato  
Polycarbonate profile  
Profil aus Polycarbonat  
Profil en polycarbonate

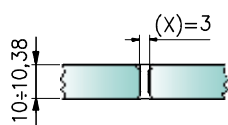
**PCC14**

Profilo in policarbonato  
Perfil en policarbonato  
Polycarbonate profile  
Profil aus Polycarbonat  
Profil en polycarbonate

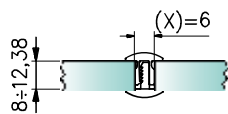
**PCC17**

Profilo in alluminio  
Perfil en aluminio  
Anodized aluminium profile  
Profil aus eloxiertem Aluminium  
Profil en aluminium

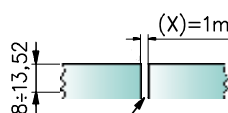

Senza profilo  
Sin perfil  
Without profile  
Ohne Profil  
Sans profil

Siliconare - Aplicar silicona  
Use silicone - Silikon verwenden  
Utilisez silicone

**P20EP60**

COPPIA DI TAPPI LATERALI spessore 0,5mm  
PAREJA DE TAPAS LATERALES espesor 0,5mm  
PAIR OF SIDE CAPS thickness 0,5mm  
SEITLICHES ENDKAPPENPAAR Dicke 0,5mm  
PAIRE DE BOUCHONS LATÉRALES 0,5mm

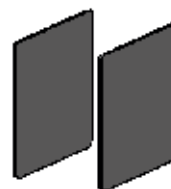
**P20EP61**

SQUADRETTA SUPERIORE DI CONTENIMENTO  
PLAQUETA SUPERIOR DE CONTENCIÓN  
UPPER CONTAINMENT PLATE  
OBERE STÜTZPLATTE  
ÉQUERRE SUPÉRIEURE DE CONTENTION

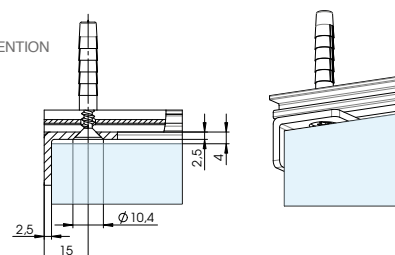
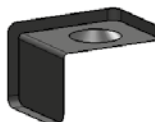

**SCHEMA DI DIMENSIONAMENTO (ESEMPIO DI VETRATA CHIUSA)**

TAMAÑO – DIAGRAMA (EJEMPLO DE CRISTALERA CERRADA)  
 SCHEME OF GLASS DIMENSIONING (EXAMPLE WITH CLOSED GLASS)  
 GLAS ABMESSUNGEN (BEISPIEL FESTVERGLASUNG)

DIMENSIONAMENTO VETRI - EVALUAR LOS VIDRIOS  
 GLASS DIMENSIONING - GLAS ABMESSUNGEN

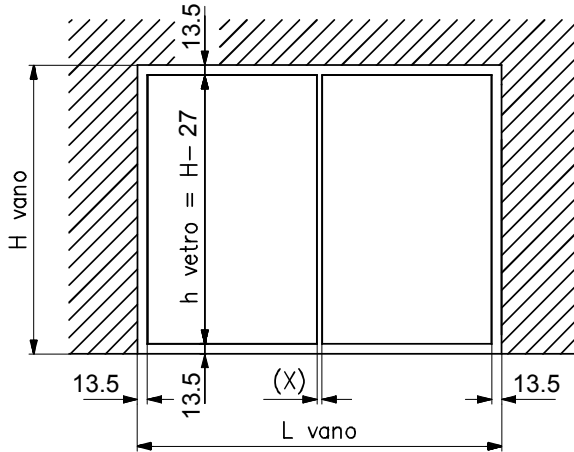

DIMENSIONAMENTO PROFILO FERMAVETRO - EVALUAR EL PERFIL REFUERZO  
 DIMENSIONING OF PROFILE - PROFILABMESSUNGEN

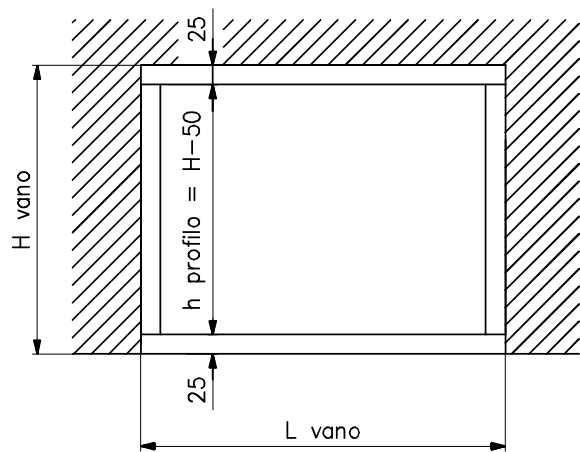

**SCHEMA DI DIMENSIONAMENTO (ESEMPIO DI VETRATA APERTA)**

TAMAÑO – DIAGRAMA (EJEMPLO DE CRISTALERA ABIERTA)  
 SCHEME OF GLASS DIMENSIONING (EXAMPLE OF OPEN GLAZING)  
 GLAS ABMESSUNGEN (BEISPIEL SEITENTEIL MIT TÜR)

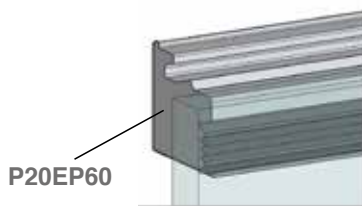

PORTA CON CERNIERE A MURO - PUERTA CON BISAGRA A PARED  
 DOOR WITH WALL HINGES - GLAS-WAND BÄNDER

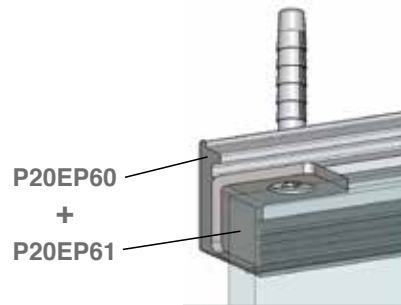

PORTA CON CERNIERE VETRO-VETRO (IL PESO DELLA PORTA GRAVA SUL FISSO)  
 PUERTA CON BISAGRA VIDRIO-VIDRIO (EL PESO DE LA PUERTA SOBRE EL VIDRIO FIJO)  
 DOOR WITH GLASS-GLASS HINGES (The door weight is beared on the fixed panel)  
 GLAS-GLAS BÄNDER (Befestigung an Seitenteil)

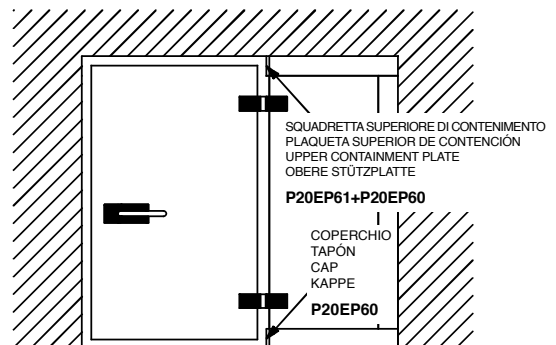
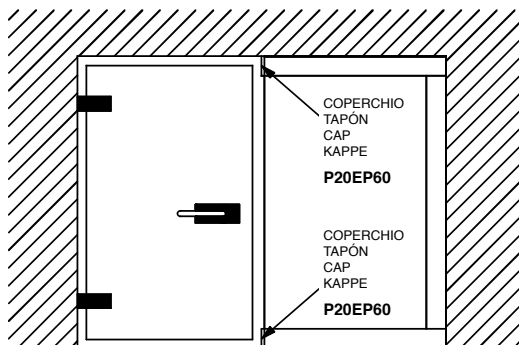

**PER INSTALLAZIONI AD ANGOLO - TAGLI A 45°**  
**PARA INSTALACIONES EN ÁNGULO – CORTAR A 45°**  
**FOR CORNER INSTALLATIONS – CUTS AT 45**  
**FÜR DEN EINBAU ÜBER ECK – GEHRUNGSSCHNITT 45°**  
**POUR MONTAGE À ANGLE- COUPE À 45°**

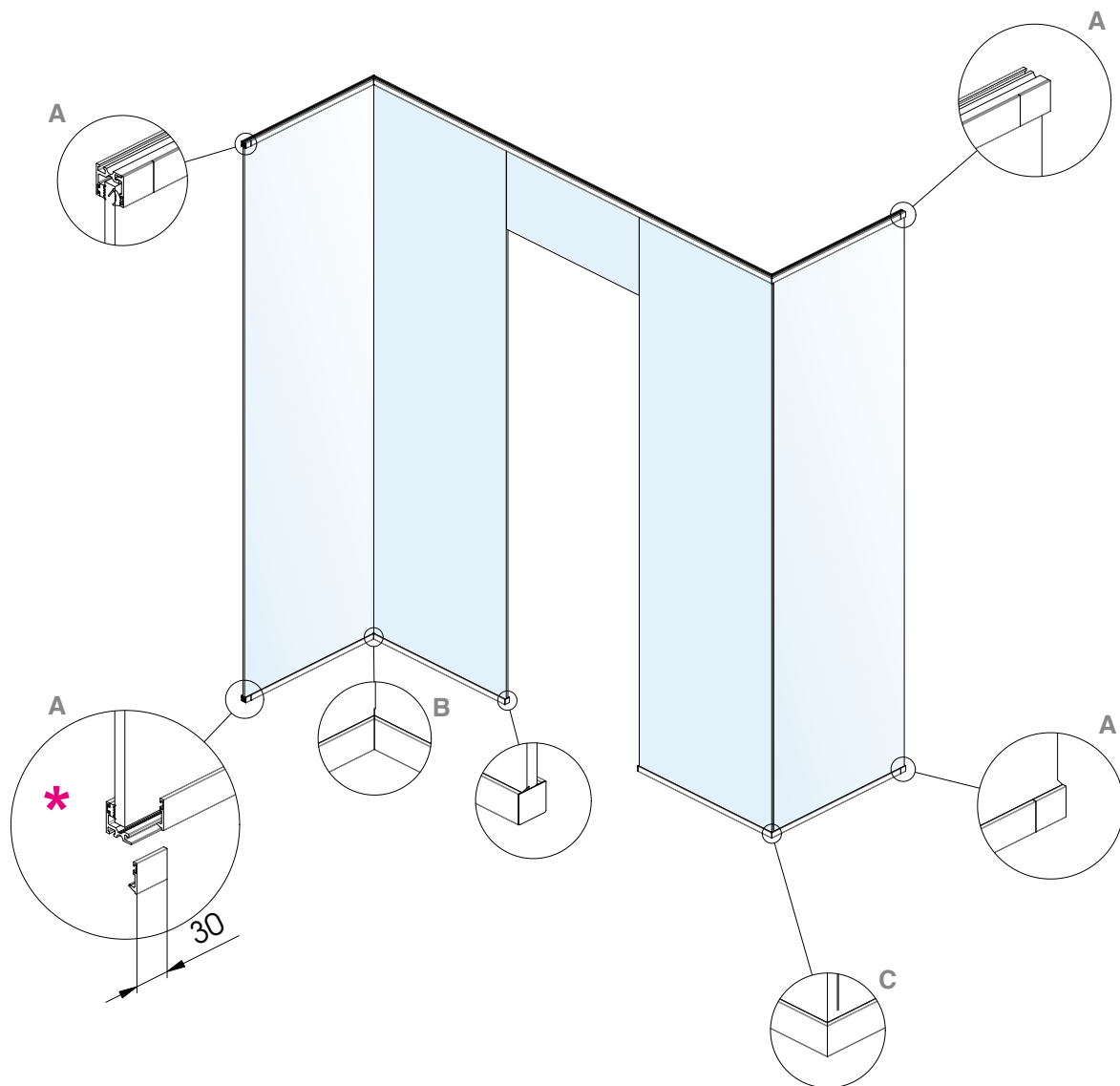

Questa applicazione prevede l'accorciamento e l'inserimento dello spezzone di profilo: vedi dettaglio.

Este tipo de aplicación preve el acortamiento e inserción del fragmento del perfil: vea detalle.

This application entails the shortening and insertion of the profile's part: see detail.

Diese Anwendung erfordert die Kürzung und Einführung des Profilstücks: Siehe Detail.

Cette application prévoit le raccourcissement et l'insertion de la partie de profil: voir détails.

- A** Accorciare il profilo di copertura a 30mm. per permettere il montaggio  
 Cortar el perfil de cobertura a 30mm para permitir el montaje  
 Cut the covering profile at 30mm in order to allow the assembly  
 Das Abdeckprofil bei 30mm schneiden um die Montage zu ermöglichen  
 Accourcir le profil de couverture à 30 mm pour permettre le montage
- B** Coperchio montato all'interno dell'angolo  
 Tapa montada en el interior del angulo  
 Cover mounted inside the corner  
 Abdeckblech innenseitig aufklipsen  
 Couvercle monté à l'intérieur de l'angle
- C** Coperchio montato all'esterno dell'angolo  
 Tapa montada en el exterior del angulo  
 Cover mounted outside the corner  
 Abdeckblech außenseitig aufklipsen  
 Couvercle monté à l'extérieur de l'angle