



Glass Wall

Pareti in vetro e accessori

Paredes de vidrio y accesorios

Glass walls and accessories

Parois vitrées et accessoires

Glaswände und Zubehör



colcomgroup.it

follow us on [f](#) [i](#) [v](#) [in](#)



Organizzare lo spazio interno

Organise indoor space

Per organizzare lo spazio interno si deve tenere conto di molti fattori: fisici, ergonomici, percettivi ed estetici e ci si deve allineare alle tendenze mutevoli del mondo dell'arredo, a maggior ragione in un contesto in continua evoluzione quale quello dell'ufficio.

Un ruolo fondamentale in uno scenario così vasto lo ricoprono le pareti divisorie, un elemento tecnico che negli anni ha aumentato le sue valenze in modo esponenziale, passando da semplice sistema divisorio a vero e proprio elemento di arredo, dotato di tutte le caratteristiche necessarie a rendere funzionale e confortevole un ambiente di lavoro.

Le nostre soluzioni sono molteplici e capaci di soddisfare le tante necessità di installazione.

Numerous factors must be considered when organising indoor space, be they physical, ergonomic, perceptive or aesthetic, and changing trends in furnishing cannot be neglected, even more so in a continually evolving setting such as an office.

Partition walls play a vital role in a scenario with endless possibilities. Over the years the importance of this technical feature has increased exponentially, going from a simple partitioning system to a fully-fledged item of furniture with all the characteristics required to make the workplace practical and comfortable.

We have numerous solutions to meet a myriad of installation requirements.



P20E

Partizioni fisse Fixed partitions

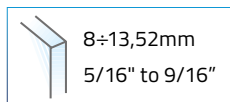

art. **P20E29**
(27 x 25mm - L = 2900 mm)

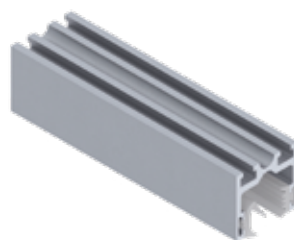

art. **P20E58**
(27 x 25mm - L = 5800 mm)

art. **P20EC29**
(27 x 25mm - L = 2900 mm)

art. **P20EC58**
(27 x 25mm - L = 5800 mm)

Nuovi profili in alluminio perfettamente abbinabili al nuovo profilo STRIQE P35E. Consentono di creare cornici essenziali per pareti continue in vetro temperato e stratificato. Adatti per applicazioni in uffici ed abitazioni in quanto permettono di suddividere facilmente gli ambienti mantenendo intatta la luminosità.

Consentono di installare vetri da 8 fino a 13,52 mm. Fissaggio pavimento e soffitto. Il formato ed il design minimale favoriscono la posa di pareti divisorie in tempi estremamente rapidi. Sono disponibili nelle finiture alluminio naturale, simil inox satinato e ossidato nero, in lunghezze di 2,9 metri e 5,8 metri.

New aluminium profiles which match perfectly with our new door frame STRIQE P35E: they allow the creation of essential frames for partitions, using both tempered and laminated glass. They are fit for office and residential applications, as they allow the easy division of spaces leaving clarity untouched. They permit to install glass between 8 and 13,52 mm thick. Floor and ceiling fixing. Their format and minimal design make the installation of glass partitions quick. Available in natural anodized and black aluminium, as well as imitation satin stainless steel. Bars of 2900 and 5800 mm.

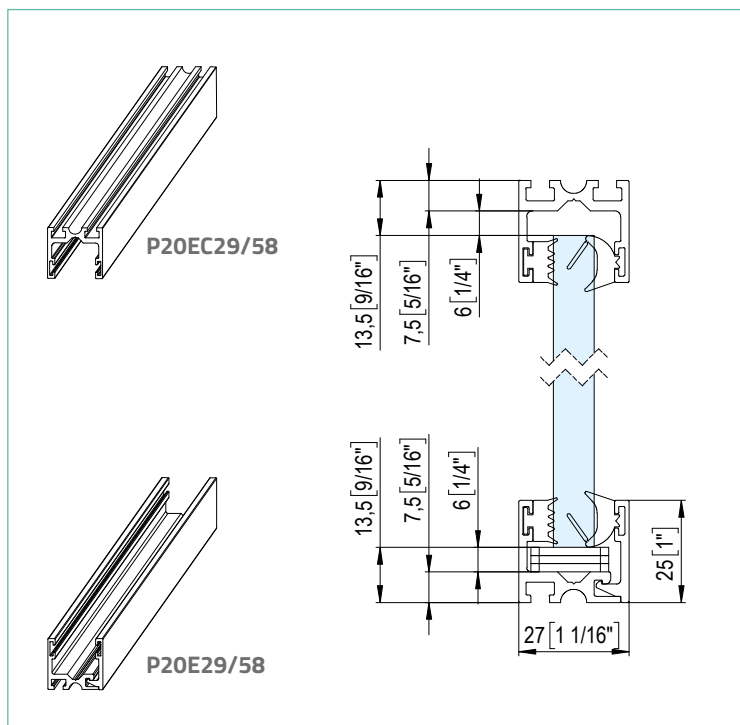



P25E

Partizioni fisse Fixed partitions

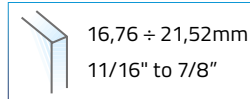

art. **P25E29**
(38 x 35mm - L = 2900 mm)



art. **P25E58**
(38 x 35mm - L = 5800 mm)

art. **P25EC29**
(38 x 35mm - L = 2900 mm)

art. **P25EC58**
(38 x 35mm - L = 5800 mm)

Nuovi profili in alluminio perfettamente abbinabili al nuovo profilo STRIQE P35E. Consentono di creare cornici essenziali per pareti continue in vetro temperato e stratificato. Adatti per applicazioni in uffici ed abitazioni in quanto permettono di suddividere facilmente gli ambienti mantenendo intatta la luminosità.

Consentono di installare vetri da 16,76 fino a 21,52 mm. Fissaggio pavimento e soffitto. Il formato ed il design minimale favoriscono la posa di pareti divisorie in tempi estremamente rapidi. Sono disponibili nelle finiture alluminio naturale, simil inox satinato e ossidato nero, in lunghezze di 2,9 metri e 5,8 metri.

New aluminium profiles which match perfectly with our new door frame STRIQE P35E: they allow the creation of essential frames for partitions, using both tempered and laminated glass. They are fit for office and residential applications, as they allow the easy division of spaces leaving clarity untouched. They permit to install glass between 16,76 and 21,52 mm thick. Floor and ceiling fixing. Their format and minimal design make the installation of glass partitions quick. Available in natural anodized and black aluminium, as well as imitation satin stainless steel. Bars of 2900 and 5800 mm.

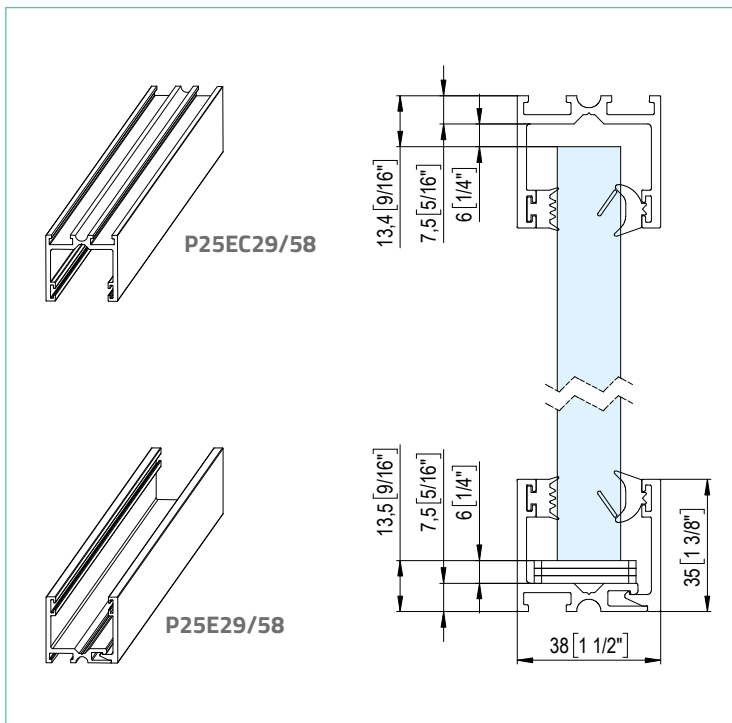



| P20E & P25E



Grande profondità visiva sono tra i caratteri distintivi.

Distinctive features include great visual depth.



La continuità visiva della parete è consentita dall'assenza dei tradizionali montanti verticali di irrigidimento.

The visual continuity of the wall is facilitated by the absence of conventional rigid vertical posts.





Come creare porte sulle pareti continue

How to create doors in continuous walls

La grande versatilità delle pareti in vetro si incontra quando la progettazione dell'ambiente interno deve integrare elementi ciechi, quali pareti in cartongesso, o quando, per esigenze di progetto, si devono soddisfare specifiche richieste funzionali.

Per questo motivo le nostre pareti in vetro sono completate dalla gamma delle porte. Battenti, scorrevoli, trasparenti o cieche, di volta in volta vanno ad adattarsi sia alle esigenze funzionali del progetto, sia al "carattere" dell'ambiente, senza mai perdere le peculiarità di grande funzionalità e praticità che una porta deve possedere.

The considerable versatility of glass walls comes into its own when indoor design has to incorporate windowless elements, such as plasterboard walls, or when specific functional requirements must be met for design purposes.

For this reason our glass walls are complete with our range of hinged, sliding, transparent and windowless doors to suit functional design requirements and the character of a setting, without losing out on the practical and functional design required of any door.



Schema per la creazione di porte

Door creation steps

1.

Scegli il profilo divisorio Choose a partition profile

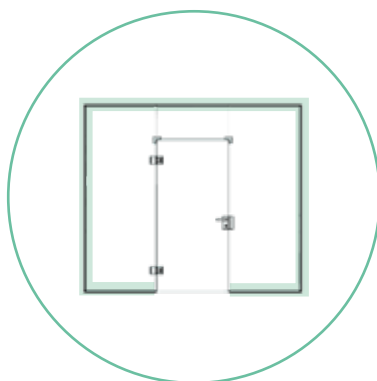

P20E - P25E
P20EC - P25EC

p. 4, 6

2.

Scegli tipologia della porta Choose door type



Porta senza profilo
Frameless door
p. 12 - 25

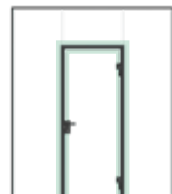

Porta con profilo
Door with frame
p. 26

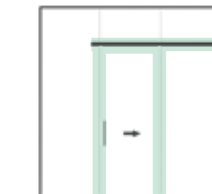

Porta scorrevole
Sliding door
p. 28

3.

Scegli tipologia di cerniera Choose hinge type

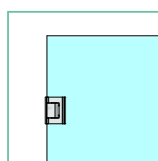

Laterale
Side
p. 12

Cerniere oleodinamiche - Oildynamic hinges
Cerniere automatiche - Automatic hinges
Cerniere a scatto - Clicking hinges
Cerniere libere - Free hinges

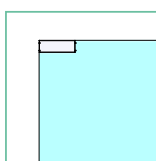

Pivot in angolo
Corner pivot
p. 17

Cerniere oleodinamiche - Oildynamic hinges
Cerniere libere - Free hinges

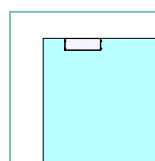

Pivot a bilico
Pivot
p. 20

Cerniere oleodinamiche - Oildynamic hinges
Cerniere libere - Free hinges

4.

Scegli tipologia di chiusura Choose closure type

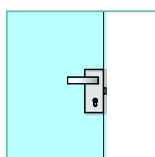

A muro
on wall
p. 24, 25

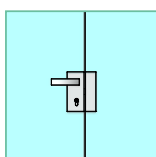

A vetro
on glass
p. 24, 25

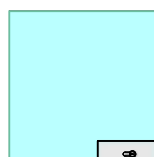







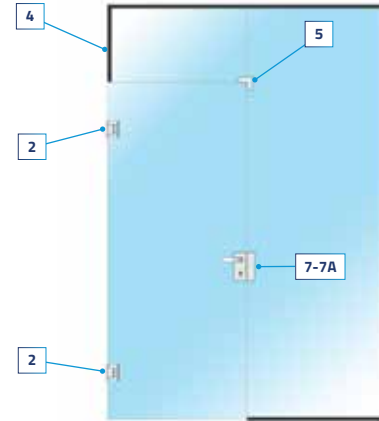
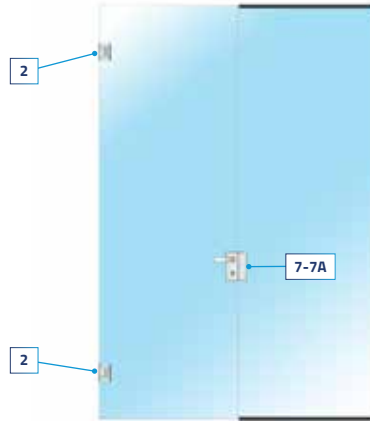



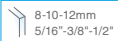
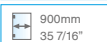
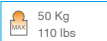

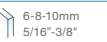
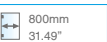
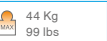

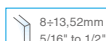



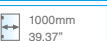
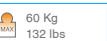

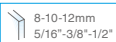
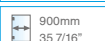
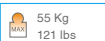

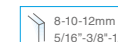



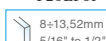

A pavimento
on floor
p. 25

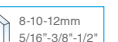
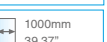
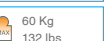
CERNIERE LATERALI anta a muro

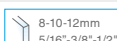
SIDE HINGES door on wall

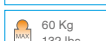

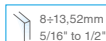







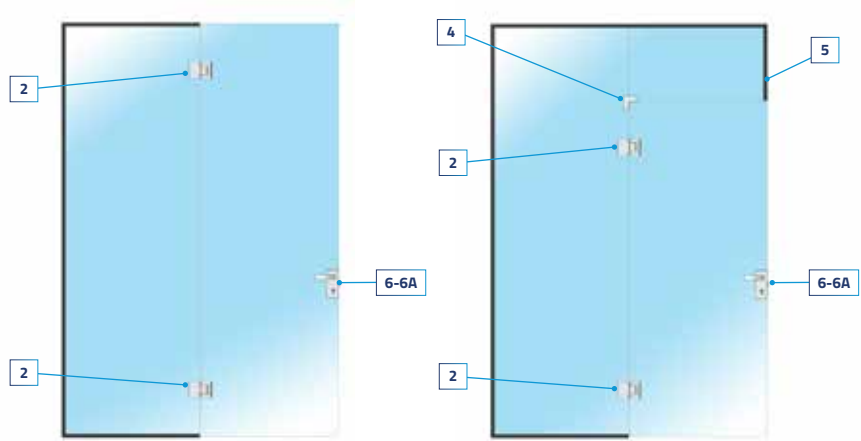





























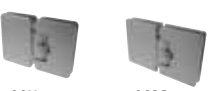

CERNIERE ATTACCO LATERALE A MURO HINGES FOR SIDE WALL MOUNTING			PILETTA SOFFITTO TOP PIVOT		ATTACCHI SOPRALUCE TRANSOM LINK FITTING		
2	2A	2B	3A	3B	4	5 - ONE WAY	5 - DOUBLE WAY
CERNIERE OLEODINAMICHE - OILDYNAMIC HINGES							
Biloba 8010 8011 8010BTJC 8+13,52mm 5/16" to 1/2" 1000mm 39.37" 100 Kg 220 lbs	-	-	-	-			 1065 10-12mm 3/8"-1/2"
Bilobina Centrale 825E00 825E10* 8-10mm 5/16"-3/8" 900mm 35 7/16" 60 Kg 132 lbs	-	-	-	-		 1060 10-12mm 3/8"-1/2"	 1065 10-12mm 3/8"-1/2"
Biloba Evo 835E10N 835E11N 8+21,52mm 5/16" to 7/8" 800+1200mm 31.49" to 47.24" 100 Kg 220 lbs	-	-	-	-	P20E+P20EP60 + P20EP61 8+13,52mm 5/16" to 1/2"	 1060 10-12mm 3/8"-1/2"	-
Biloba 8060 8-10-12mm 5/16"-3/8"-1/2" 1000mm 39.37" 100 Kg 220 lbs	-	-	-	-			-
CERNIERE AUTOMATICHE - AUTOMATIC HINGES							
 8609 8610 8-10-12mm 5/16"-3/8"-1/2" 900mm 35 7/16" 60 Kg 132 lbs	-	-	-	-	 P20E+P20EP60 + P20EP61 8+13,52mm 5/16" to 1/2"		 1065 10-12mm 3/8"-1/2"
 8630 8631 8-10-12mm 5/16"-3/8"-1/2" 900mm 35 7/16" 60 Kg 132 lbs	-	-	-	-	 P20E+P20EP60 + P20EP61 8+13,52mm 5/16" to 1/2"		 1065 10-12mm 3/8"-1/2"
CERNIERE A SCATTO - CLICKING HINGES							
 8700 8701* 8-10-12mm 5/16"-3/8"-1/2" 900mm 35 7/16" 60 Kg 132 lbs	-	-	-	-	 P20E+P20EP60 + P20EP61 8+13,52mm 5/16" to 1/2"	 1060 10-12mm 3/8"-1/2"	 1065 10-12mm 3/8"-1/2"













CERNIERE ATTACCO LATERALE A MURO HINGES FOR SIDE WALL MOUNTING			PILETTA SOFFITTO TOP PIVOT		ATTACCHI SOPRALUCE TRANSOM LINK FITTING		
2	2A	2B	3A	3B	4	5 - ONE WAY	5 - DOUBLE WAY
CERNIERE LIBERE - FREE HINGES							
STIPITI STRETTI - STRAITS DOORJAMBS							
 8650   	-	-	-	-			-
 8654   	-	-	-	-	 	 	-
 8633   	-	-	-	-			-
STIPITI DOORJAMBS 30/42mm							
 8664							
 8665   	-	-	-	-			-
 8810   	-	-	-	-	 	 	-
 8674   	-	-	-	-			-
STIPITI DOORJAMBS 40/50mm							
 8666							
 8667   	-	-	-	-	 	 	-

CERNIERE LATERALI anta a vetro

SIDE HINGES door on glass



CERNIERE ATTACCO LATERALE VETRO-VETRO HINGES FOR SIDE GLASS-GLASS MOUNTING			PILETTA SOFFITTO TOP PIVOT		ATTACCHI SOPRALUCE TRANSOM LINK FITTING		
2	2A	2B	3A	3B	4	5 - ONE WAY	5 - DOUBLE WAY
CERNIERE OLEODINAMICHE - OILDYNAMIC HINGES							
Biloba  8015 <div style="border: 1px solid black; padding: 2px; width: fit-content;">  8÷13,52mm 5/16" to 1/2" </div> <div style="border: 1px solid black; padding: 2px; width: fit-content;">  1000mm 39.37" </div> <div style="border: 1px solid black; padding: 2px; width: fit-content;">  100 Kg 220 lbs </div>	—	—	—	—			 P20E+P20EP60 + P20EP61 <div style="border: 1px solid black; padding: 2px; width: fit-content;">  8÷13,52mm 5/16" to 1/2" </div> <i>o / or</i>  P20E+1075 <div style="border: 1px solid black; padding: 2px; width: fit-content;">  10-12mm 3/8"-1/2" </div>
Biloba JC  8015BTJC* <div style="border: 1px solid black; padding: 2px; width: fit-content;">  8-10-12mm 5/16"-3/8"-1/2" </div> <div style="border: 1px solid black; padding: 2px; width: fit-content;">  1000mm 39.37" </div> <div style="border: 1px solid black; padding: 2px; width: fit-content;">  80 Kg 176 lbs </div>	—	—	—	—			 P20E <div style="border: 1px solid black; padding: 2px; width: fit-content;">  8÷13,52mm 5/16" to 1/2" </div>  1070 <div style="border: 1px solid black; padding: 2px; width: fit-content;">  10-12mm 3/8"-1/2" </div>
Biloba Evo  835E50 835E51 <div style="border: 1px solid black; padding: 2px; width: fit-content;">  8÷21,52mm 5/16" to 7/8" </div> <div style="border: 1px solid black; padding: 2px; width: fit-content;">  800÷1200mm 31.49" to 47.24" </div> <div style="border: 1px solid black; padding: 2px; width: fit-content;">  100 Kg 220 lbs </div>	—	—	—	—	 1065 <div style="border: 1px solid black; padding: 2px; width: fit-content;">  10-12mm 3/8"-1/2" </div>		
Bilobina Centrale  825E50 <div style="border: 1px solid black; padding: 2px; width: fit-content;">  8-10mm 5/16"-3/8" </div> <div style="border: 1px solid black; padding: 2px; width: fit-content;">  900mm 35 7/16" </div> <div style="border: 1px solid black; padding: 2px; width: fit-content;">  60 Kg 132 lbs </div>	—	—	—	—			 P20E+P20EP60 + P20EP61 <div style="border: 1px solid black; padding: 2px; width: fit-content;">  8÷13,52mm 5/16" to 1/2" </div> <i>o / or</i>  P20E+1075 <div style="border: 1px solid black; padding: 2px; width: fit-content;">  10-12mm 3/8"-1/2" </div>
CERNIERE AUTOMATICHE - AUTOMATIC HINGES							
 8611 8635 <div style="border: 1px solid black; padding: 2px; width: fit-content;">  8-10-12mm 5/16"-3/8"-1/2" </div> <div style="border: 1px solid black; padding: 2px; width: fit-content;">  900mm 35 7/16" </div> <div style="border: 1px solid black; padding: 2px; width: fit-content;">  50 Kg 110 lbs </div>	—	—	—	—	 1065 <div style="border: 1px solid black; padding: 2px; width: fit-content;">  10-12mm 3/8"-1/2" </div>		 P20E+P20EP60 + P20EP61 <div style="border: 1px solid black; padding: 2px; width: fit-content;">  8÷13,52mm 5/16" to 1/2" </div> <i>o / or</i>  P20E+1075 <div style="border: 1px solid black; padding: 2px; width: fit-content;">  10-12mm 3/8"-1/2" </div>

CERNIERE PIVOT A BILICO PIVOT HINGES			PILETTA SOFFITTO TOP PIVOT		ATTACCHI SOPRALUCE TRANSOM LINK FITTING		
2	2A	2B	3A	3B	4	5 - ONE WAY	5 - DOUBLE WAY
CERNIERE A SCATTO - CLICKING HINGES							
 <p>8705</p> <ul style="list-style-type: none"> 8-10-12mm 5/16"-3/8"-1/2" 900mm 35 7/16" 50 Kg 110 lbs 	-	-	-	-	 <p>1065</p> <ul style="list-style-type: none"> 10-12mm 3/8"-1/2" 	 <p>P20E</p> <ul style="list-style-type: none"> 8+13,52mm 5/16" to 1/2"  <p>1070</p> <ul style="list-style-type: none"> 10-12mm 3/8"-1/2" 	 <p>P20E+P20EP60 + P20EP61</p> <ul style="list-style-type: none"> 8+13,52mm 5/16" to 1/2" <p><i>o / or</i></p>  <p>P20E+1075</p> <ul style="list-style-type: none"> 10-12mm 3/8"-1/2"
CERNIERE LIBERE - FREE HINGES							
 <p>8655</p> <ul style="list-style-type: none"> 6-8-10mm 5/16"-3/8" 800mm 31.49" 40 Kg 88 lbs 	-	-	-	-	 <p>1065</p> <ul style="list-style-type: none"> 10-12mm 3/8"-1/2" 	 <p>P20E</p> <ul style="list-style-type: none"> 8+13,52mm 5/16" to 1/2" 	-
 <p>8652</p> <ul style="list-style-type: none"> 8-10-12mm 5/16"-3/8"-1/2" 900mm 35 7/16" 50 Kg 110 lbs 	-	-	-	-	 <p>1065</p> <ul style="list-style-type: none"> 10-12mm 3/8"-1/2" 	 <p>1070</p> <ul style="list-style-type: none"> 10-12mm 3/8"-1/2" 	-

CERNIERE LATERALI anta centrale

SIDE HINGES central door

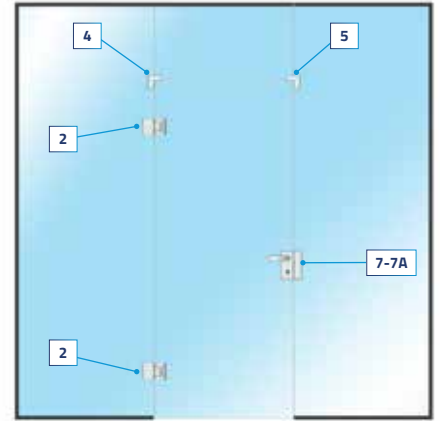
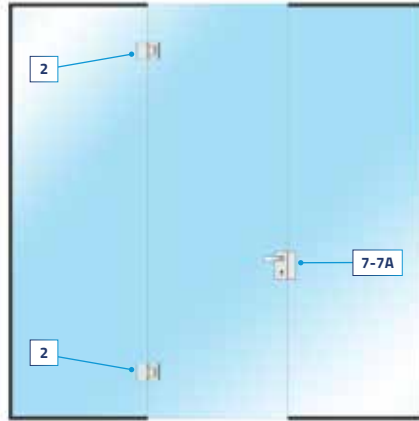







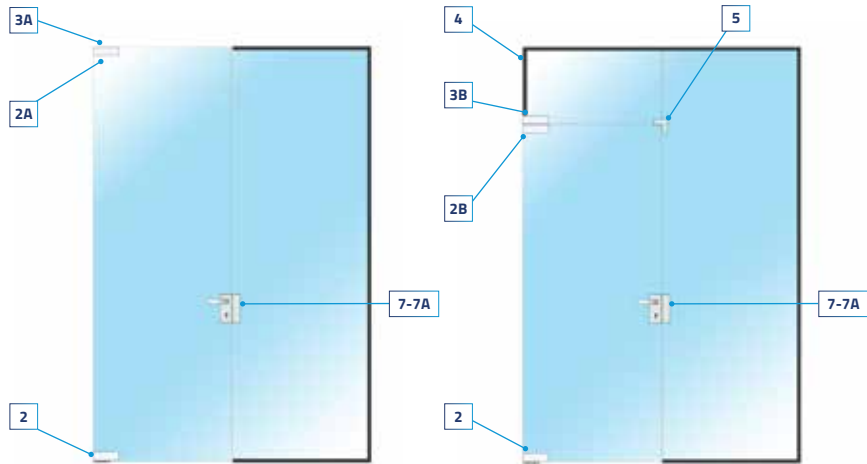













CERNIERE ATTACCO LATERALE VETRO-VETRO HINGES FOR SIDE GLASS-GLASS MOUNTING			PILETTA SOFFITTO TOP PIVOT		ATTACCHI SOPRALUCE TRANSOM LINK FITTING				
2			2A	2B	3A	3B	4	5 - ONE WAY	5 - DOUBLE WAY
CERNIERE OLEODINAMICHE - OILDYNAMIC HINGES									
Biloba		<ul style="list-style-type: none"> 8±13,52mm 5/16" to 1/2" 1000mm 39.37" 100 Kg 220 lbs 	-	-	-	-	-	-	-
8015									
Biloba JC		<ul style="list-style-type: none"> 8-10-12mm 5/16"-3/8"-1/2" 1000mm 39.37" 80 Kg 176 lbs 	-	-	-	-	-	-	 10-12mm 3/8"-1/2"
8015BTJC*									
Biloba Evo		<ul style="list-style-type: none"> 8±21,52mm 5/16" to 7/8" 800±1200mm 31.49" to 47.24" 100 Kg 220 lbs 	-	-	-	-	 10-12mm 3/8"-1/2"	 10-12mm 3/8"-1/2"	-
835E50	835E51								
Bilobina Centrale		<ul style="list-style-type: none"> 8-10mm 5/16"-3/8" 900mm 35 7/16" 60 Kg 132 lbs 	-	-	-	-	-	-	 10-12mm 3/8"-1/2"
825E50									
CERNIERE AUTOMATICHE - AUTOMATIC HINGES									
		<ul style="list-style-type: none"> 8-10-12mm 5/16"-3/8"-1/2" 900mm 35 7/16" 50 Kg 110 lbs 	-	-	-	-	 10-12mm 3/8"-1/2"	-	 10-12mm 3/8"-1/2"
8611	8635								
CERNIERE A SCATTO - CLICKING HINGES									
		<ul style="list-style-type: none"> 8-10-12mm 5/16"-3/8"-1/2" 900mm 35 7/16" 50 Kg 110 lbs 	-	-	-	-	 10-12mm 3/8"-1/2"	 10-12mm 3/8"-1/2"	 10-12mm 3/8"-1/2"
8705									
CERNIERE LIBERE - FREE HINGES									
		<ul style="list-style-type: none"> 6-8-10mm 5/16"-3/8" 800mm 31.49" 40 Kg 88 lbs 					 10-12mm 3/8"-1/2"	 10-12mm 3/8"-1/2"	-
8655	8652								

CERNIERE PIVOT IN ANGOLO

anta a muro PIVOT CORNER HINGES door on wall



CERNIERE PIVOT IN ANGOLO PIVOT HINGES IN CORNER			PILETTA SOFFITTO TOP PIVOT	ATTACCHI SOPRALUCE TRANSOM LINK FITTING			
2	2A	2B	3A	3B	4	5 - ONE WAY	5 - DOUBLE WAY
CERNIERE OLEODINAMICHE - OILDYNAMIC HINGES							
Biloba DUO  150E00 8+19,5mm 5/16" to 3/4" 1200mm 47.24" 150 Kg 330 lbs							
Triloba  8200 10-12mm 3/8"-1/2" 1200mm 47.24" 150 Kg 330 lbs							
Biloba Unica  101E10 8+13,52mm 5/16" to 1/2" 1000mm 39.37" 100 Kg 220 lbs	 100E20 8+13,52mm 5/16" to 1/2" 1000mm 39.37" 100 Kg 220 lbs		 1027	 AI00E40+100E25 8+13,52mm 5/16" to 1/2"	 P20E 8+13,52mm 5/16" to 1/2"	 1060 10-12mm 3/8"-1/2"	 1065 10-12mm 3/8"-1/2"
Biloba Unica NF  101E10NF 8+13,52mm 5/16" to 1/2" 1000mm 39.37" 100 Kg 220 lbs							
 1010 + CHD1 10-12 3/8"-1/2" 1000mm 39.37" 66 Kg 145 lbs	 1020 10-12 3/8"-1/2" 1000mm 39.37" 66 Kg 145 lbs			 1040 10-12mm 3/8"-1/2"			
CERNIERE LIBERE - FREE HINGES							
 1010 + 1730 10-12 3/8"-1/2" 1000mm 39.37" 66 Kg 145 lbs	 1020 10-12 3/8"-1/2" 1000mm 39.37" 66 Kg 145 lbs		 1027	 1040 10-12mm 3/8"-1/2"	 P20E 8+13,52mm 5/16" to 1/2"	 1060 10-12mm 3/8"-1/2"	 1065 10-12mm 3/8"-1/2"

CERNIERE PIVOT IN ANGOLO

anta a vetro
PIVOT CORNER HINGES
door on glass

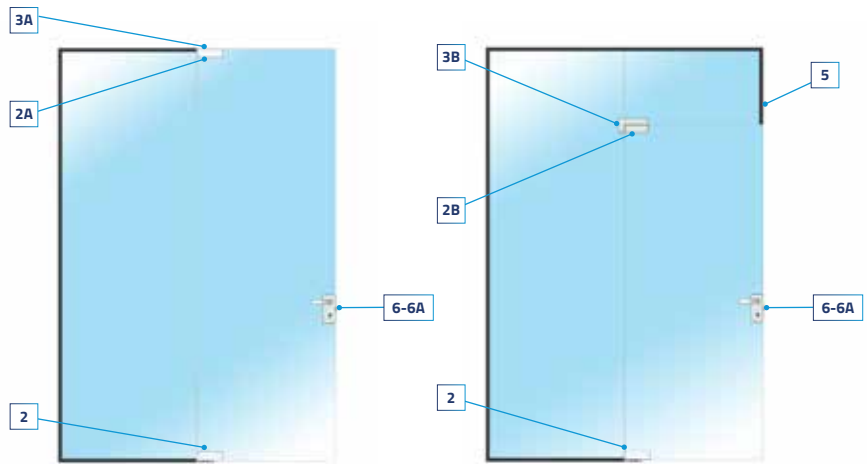







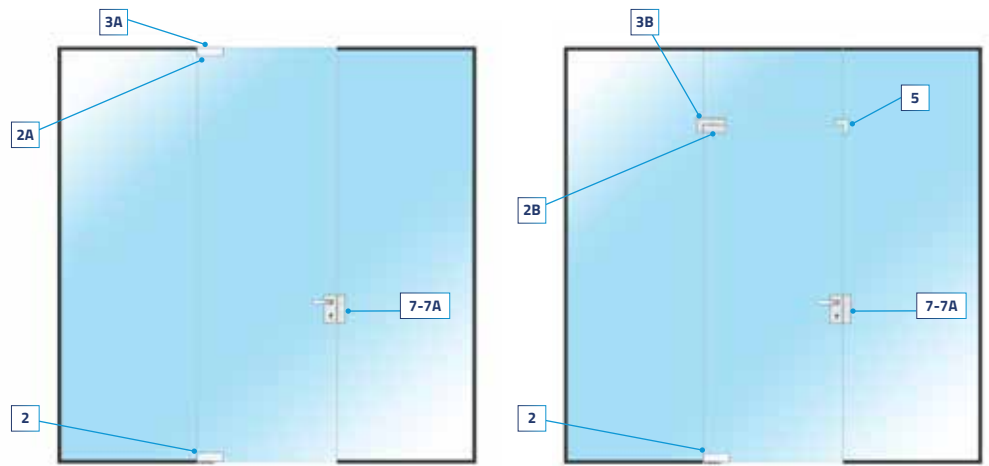











































CERNIERE PIVOT IN ANGOLO PIVOT HINGES IN CORNER			PILETTA SOFFITTO TOP PIVOT	ATTACCHI SOPRALUCE TRANSOM LINK FITTING			
2	2A	2B	3A	3B	4	5 - ONE WAY	5 - DOUBLE WAY
CERNIERE OLEODINAMICHE - OILDYNAMIC HINGES							
Biloba DUO 150E00 8+19,5mm 5/16" to 3/4" 1200mm 47.24" 150 Kg 330 lbs							
Biloba Unica 101E10 8+13,52mm 5/16" to 1/2" 1000mm 39.37" 100 Kg 220 lbs	 100E20	 1020 10-12 3/8"-1/2" 1000mm 39.37" 66 Kg 145 lbs				 P20E 8+13,52mm 5/16" to 1/2" 1070	 P20E+P20EP60 + P20EP61 8+13,52mm 5/16" to 1/2" o/or P20E+1075
Biloba Unica NF 101E10NF 8+13,52mm 5/16" to 1/2" 1000mm 39.37" 100 Kg 220 lbs	 100E20 8+13,52mm 5/16" to 1/2" 1000mm 39.37" 100 Kg 220 lbs	 1020 10-12 3/8"-1/2" 1000mm 39.37" 66 Kg 145 lbs	 1027	 1050 10-12mm 3/8"-1/2"		 1070 10-12mm 3/8"-1/2"	 P20E+1075 10-12mm 3/8"-1/2"
 1010 + CHD1 10-12 3/8"-1/2" 1000mm 39.37" 66 Kg 145 lbs	 1020 10-12 3/8"-1/2" 1000mm 39.37" 66 Kg 145 lbs						
CERNIERE LIBERE - FREE HINGES							
 1010 + 1730 10-12 3/8"-1/2" 1000mm 39.37" 66 Kg 145 lbs	 1020 10-12 3/8"-1/2" 1000mm 39.37" 66 Kg 145 lbs		 1027	 1050 10-12mm 3/8"-1/2"		 1070 10-12mm 3/8"-1/2"	 P20E+P20EP60 + P20EP61 8+13,52mm 5/16" to 1/2" o/or P20E+1075 10-12mm 3/8"-1/2"

CERNIERE PIVOT IN ANGOLO anta centrale

PIVOT CORNER HINGES central door









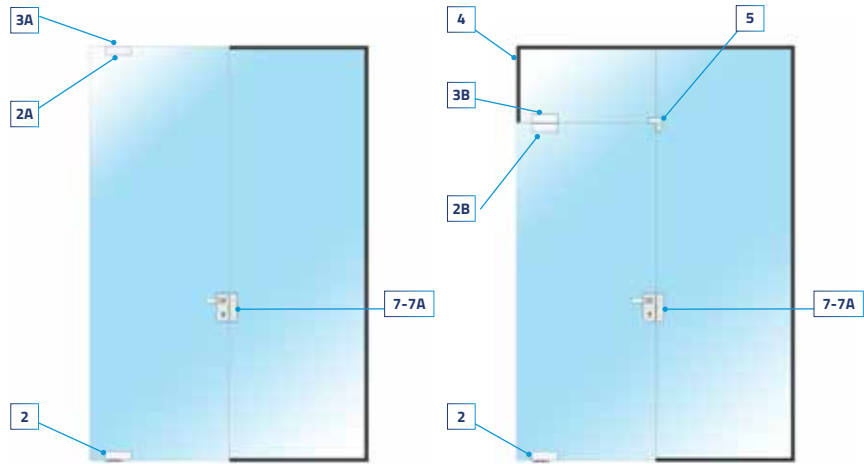











CERNIERE PIVOT IN ANGOLO PIVOT HINGES IN CORNER			PILETTA SOFFITTO TOP PIVOT	ATTACCHI SOPRALUCE TRANSOM LINK FITTING			
2	2A	2B	3A	3B	4	5 - ONE WAY	5 - DOUBLE WAY
CERNIERE OLEODINAMICHE - OILDYNAMIC HINGES							
Biloba DUO  150E00 <div style="display: flex; flex-direction: column; gap: 5px;"> <div> 8+19,5mm 5/16" to 3/4"</div> <div> 1200mm 47.24"</div> <div> 150 Kg 330 lbs</div> </div>			-	-	-	-	-
Biloba Unica  101E10 <div style="display: flex; flex-direction: column; gap: 5px;"> <div> 8+13,52mm 5/16" to 1/2"</div> <div> 1000mm 39.37"</div> <div> 100 Kg 220 lbs</div> </div>	 100E20	 1020			-		
Biloba Unica NF  101E10NF <div style="display: flex; flex-direction: column; gap: 5px;"> <div> 8+13,52mm 5/16" to 1/2"</div> <div> 1000mm 39.37"</div> <div> 100 Kg 220 lbs</div> </div>	<div style="display: flex; flex-direction: column; gap: 5px;"> <div> 8+13,52mm 5/16" to 1/2"</div> <div> 1000mm 39.37"</div> <div> 100 Kg 220 lbs</div> </div>	<div style="display: flex; flex-direction: column; gap: 5px;"> <div> 10-12 3/8"-1/2"</div> <div> 1000mm 39.37"</div> <div> 66 Kg 145 lbs</div> </div>	 1027	 1050 <div style="display: flex; flex-direction: column; gap: 5px;"> <div> 10-12mm 3/8"-1/2"</div> </div>	-	 1060 <div style="display: flex; flex-direction: column; gap: 5px;"> <div> 10-12mm 3/8"-1/2"</div> </div>	 1065 <div style="display: flex; flex-direction: column; gap: 5px;"> <div> 10-12mm 3/8"-1/2"</div> </div>
 1010 + CHD1 <div style="display: flex; flex-direction: column; gap: 5px;"> <div> 10-12 3/8"-1/2"</div> <div> 1000mm 39.37"</div> <div> 66 Kg 145 lbs</div> </div>	 1020 <div style="display: flex; flex-direction: column; gap: 5px;"> <div> 10-12 3/8"-1/2"</div> <div> 1000mm 39.37"</div> <div> 66 Kg 145 lbs</div> </div>				-		
CERNIERE LIBERE - FREE HINGES							
 1010 + 1730 <div style="display: flex; flex-direction: column; gap: 5px;"> <div> 10-12 3/8"-1/2"</div> <div> 1000mm 39.37"</div> <div> 66 Kg 145 lbs</div> </div>	 1020 <div style="display: flex; flex-direction: column; gap: 5px;"> <div> 10-12 3/8"-1/2"</div> <div> 1000mm 39.37"</div> <div> 66 Kg 145 lbs</div> </div>	 1027	 1050 <div style="display: flex; flex-direction: column; gap: 5px;"> <div> 10-12mm 3/8"-1/2"</div> </div>	-	 1060 <div style="display: flex; flex-direction: column; gap: 5px;"> <div> 10-12mm 3/8"-1/2"</div> </div>	 1065 <div style="display: flex; flex-direction: column; gap: 5px;"> <div> 10-12mm 3/8"-1/2"</div> </div>	

CERNIERE PIVOT A BILICO anta a muro

PIVOT HINGES door on wall









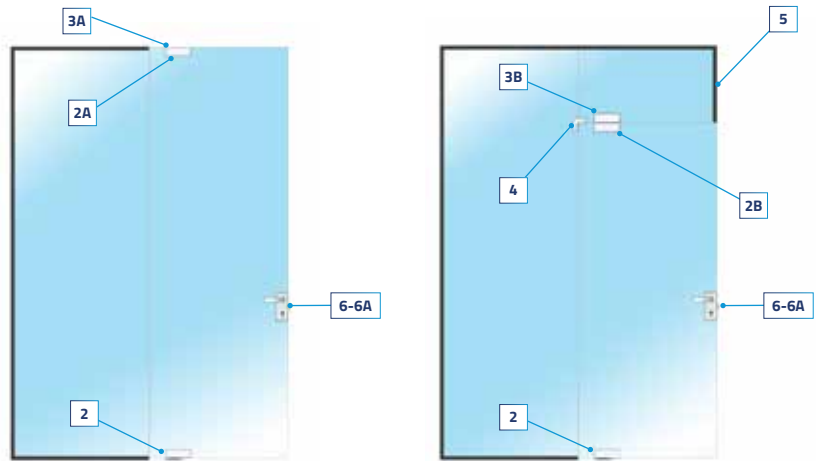















CERNIERE PIVOT A BILICO PIVOT HINGES			PILETTA SOFFITTO TOP PIVOT	ATTACCHI SOPRALUCE TRANSOM LINK FITTING				
2	2A	2B	3A	3B	4	5 - ONE WAY	5 - DOUBLE WAY	
CERNIERE OLEODINAMICHE - OILDYNAMIC HINGES								
Biloba DUO  150E00 8x19,5mm 5/16" to 3/4" 1200mm 47.24" 150 Kg 330 lbs								
Triloba -								
Biloba Unica  101E10 8x13,52mm 5/16" to 1/2" 1000mm 39.37" 100 Kg 220 lbs								
Biloba Unica NF  101E10NF 8x13,52mm 5/16" to 1/2" 1000mm 39.37" 100 Kg 220 lbs	 100E20 8x13,52mm 5/16" to 1/2" 1000mm 39.37" 100 Kg 220 lbs		 1027	 100E25 8x13,52mm 5/16" to 1/2"	 P20E+P20EP60 + P20EP61 8x13,52mm 5/16" to 1/2"	 1060 10-12mm 3/8"-1/2"	 1065 10-12mm 3/8"-1/2"	
 1810 + CHD1 10-12mm 3/8"-1/2" 1200mm 47.24" 80 Kg 1476 lbs		 1820 10-12mm 3/8"-1/2" 1200mm 47.24" 80 Kg 1476 lbs		 1825 10-12mm 3/8"-1/2"				
CERNIERE LIBERE - FREE HINGES								
 1810 + 1730 10-12mm 3/8"-1/2" 1200mm 47.24" 80 Kg 1476 lbs		 1820 10-12mm 3/8"-1/2" 1200mm 47.24" 80 Kg 1476 lbs		 1027	 1825 10-12mm 3/8"-1/2"	 P20E+P20EP60 + P20EP61 8x13,52mm 5/16" to 1/2"	 1060 10-12mm 3/8"-1/2"	 1065 10-12mm 3/8"-1/2"

CERNIERE PIVOT A BILICO anta a vetro

PIVOT HINGES door on glass









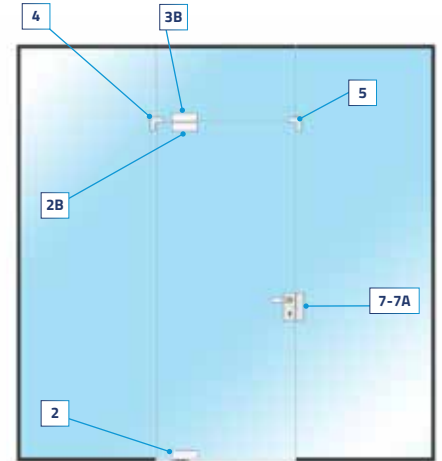
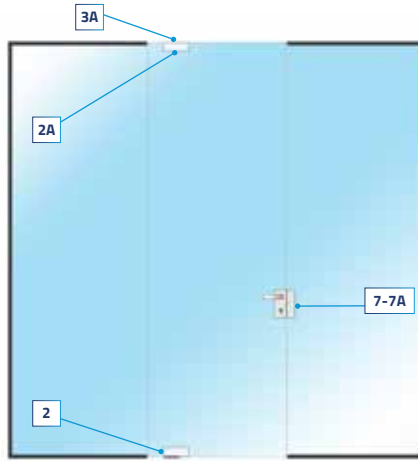

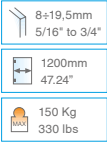

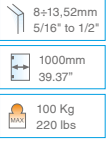

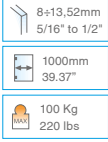

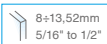







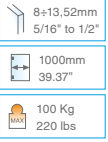

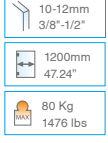

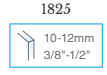



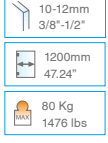

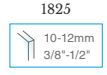









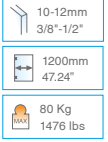

CERNIERE PIVOT A BILICO PIVOT HINGES			PILETTA SOFFITTO TOP PIVOT		ATTACCHI SOPRALUCE TRANSOM LINK FITTING		
2	2A	2B	3A	3B	4	5 - ONE WAY	5 - DOUBLE WAY
CERNIERE OLEODINAMICHE - OILDYNAMIC HINGES							
Biloba DUO  150E00 8+19,5mm 5/16" to 3/4" 1200mm 47.24" 150 Kg 330 lbs							
Triloba -							
Biloba Unica  101E10 8+13,52mm 5/16" to 1/2" 1000mm 39.37" 100 Kg 220 lbs							
Biloba Unica NF  101E10NF 8+13,52mm 5/16" to 1/2" 1000mm 39.37" 100 Kg 220 lbs	 100E20 8+13,52mm 5/16" to 1/2" 1000mm 39.37" 100 Kg 220 lbs		 1027	 100E25 8+13,52mm 5/16" to 1/2"	 1065 10-12mm 3/8"-1/2"	 P20E 8+13,52mm 5/16" to 1/2"	 P20E+P20EP60 + P20EP61 8+13,52mm 5/16" to 1/2"
 1810 + CHD1 10-12mm 3/8"-1/2" 1200mm 47.24" 80 Kg 1476 lbs	 1820 10-12mm 3/8"-1/2" 1200mm 47.24" 80 Kg 1476 lbs			 1825 10-12mm 3/8"-1/2"		 1070 10-12mm 3/8"-1/2"	 P20E+1075 10-12mm 3/8"-1/2"
CERNIERE LIBERE - FREE HINGES							
 1810 + 1780 10-12mm 3/8"-1/2" 1200mm 47.24" 80 Kg 1476 lbs	 1820 10-12mm 3/8"-1/2" 1200mm 47.24" 80 Kg 1476 lbs		 1027	 1825 10-12mm 3/8"-1/2"	 1065 10-12mm 3/8"-1/2"	 P20E 8+13,52mm 5/16" to 1/2"	 P20E+P20EP60 + P20EP61 8+13,52mm 5/16" to 1/2"
						 1070 10-12mm 3/8"-1/2"	 P20E+1075 10-12mm 3/8"-1/2"

CERNIERE PIVOT A BILICO anta centrale

PIVOT HINGES central door



CERNIERE PIVOT A BILICO PIVOT HINGES			PILETTA SOFFITTO TOP PIVOT	ATTACCHI SOPRALUCE TRANSOM LINK FITTING			
2	2A	2B	3A	3B	4	5 - ONE WAY	5 - DOUBLE WAY
CERNIERE OLEODINAMICHE - OILDYNAMIC HINGES							
Biloba DUO  150E00 							
Triloba -	-	-	-	-	-	-	-
Biloba Unica  101E10 		 100E20 	 1027	 100E25 	 1065 	 1060 	 1065 
Biloba Unica NF  101E10NF 		 1820 	 1027	 1825 			
 1810 + CHD1 		 1820 	 1027	 1825 	 1065 	 1060 	 1065 
CERNIERE LIBERE - FREE HINGES							
 1810 + 1730 		 1820 	 1027	 1825 	 1065 	 1060 	 1065 



Chiusure per soluzioni frameless

Closure for frameless doors

CHIUSURA A MURO WALL CLOSURE		SERRATURA LOCK	CHIUSURA A VETRO GLASS CLOSURE	
6 - ONE WAY	6A - DOUBLE WAY		7 - ONE WAY	7A - DOUBLE WAY
FLEXA				
 0641	—	 6410	 6415	—
	—	 6411 / 6411A		—
	—	 6412 / 6412A		—
VERTICALE				
 0620E10	—	 620E10	 620E50	—
VERTICALE MAGNETICA				
 0622E10	—	 622E10	 622E50	—
—	 0622E11	 623E10	—	 623E50
MAXIMA				
 0035	 0030	 6040	—	 6050
 0035	 0030	 6630	 6835	 6830
 0045	—	 6640	 6845	—
	—	 6641		—
	 0040	 6645		 6840

Chiusure per soluzioni frameless

Closure for frameless doors

CHIUSURA A MURO WALL CLOSURE		SERRATURA LOCK	CHIUSURA A VETRO GLASS CLOSURE	
6 - ONE WAY	6A - DOUBLE WAY		7 - ONE WAY	7A - DOUBLE WAY
LOQ				
0671W10 	—	 Tutta la serie - All series	 Tutta la serie - All series	—
LOQ MAGNETIC				
0683W11MGR 	—	 Tutta la serie - All series	 683W50M / 684W50M	—
APERTURA CON INCONTRO ELETTRICO - OPENING WITH ELECTRIC STRIKE				
 6870	—	6640 	—	—
	—	6641 	 6875	—
	—	6652N 	—	—
	—	LOQ  Tutta la serie - All series	—	—
CHIUSURA A PAVIMENTO - FLOOR CLOSURE				
—	—	1080 	—	—
—	0130 	100E30 	—	—
—	A05W50 (included) 	500W50 	—	—

 Magnetico / Magnetic

 Elettrico / Electric

P35E STRIQE



Porte con profilo Doors with frame



art. **P35E**
(L = 5800 mm)

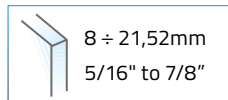

P35E è il primo profilo in alluminio modulabile disponibile sul mercato, in grado di ospitare spessori di vetro compresi tra 8 mm. e 21.52 mm. È adatto per applicazioni in uffici ed abitazioni e permette di suddividere facilmente gli ambienti mantenendo intatta la luminosità. Il formato ed il design minimale favoriscono la posa di pareti divisorie in tempi estremamente rapidi.

NEW STRIQE è la soluzione ideale per creare cornici essenziali ad ingressi in muratura e pareti in vetro. È perfettamente abbinabile al profilo per pareti divisorie P20E e P25E, alle cerniere e serrature di Colcom. NEW STRIQE è fornito in barre da 5800 mm di lunghezza ed è disponibile nelle finiture alluminio naturale, simil inox satinato e ossidato nero.

Installazione rapida semplice e veloce. Possibilità di regolazione in altezza e profondità.

P35E is the first hybrid aluminium system available on the market which can accommodate glass thicknesses ranging from 8 mm to 21,52 mm. It is suitable for office and residential applications, and allows to divide interior spaces easily, leaving brightness untouched. Its format and minimal design make the installation of glass walls quick.

New Strique is the ideal solution to create essential frames for brickwork thresholds and glass walls. It is perfectly combinable with the profiles for glass partitioning P20E and P25E, as well as with locks and hinges from Colcom range.

NEW STRIQE is supplied in 5800 mm long bars, in the following finishes: natural anodized aluminium, imitations satin stainless steel, black anodized aluminium.

Quick and easy installation. Height and depth adjustment possibility.

Soluzioni porte con profilo con P35E

Doors frame solutions with P35E

Anta a tutta altezza

Door - full height

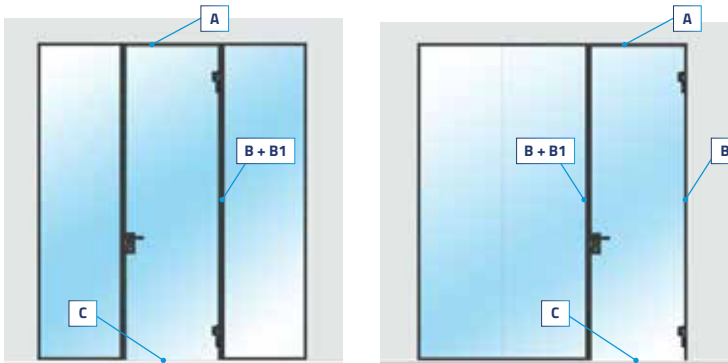

Anta con sopra luce

Door - with transom fitting

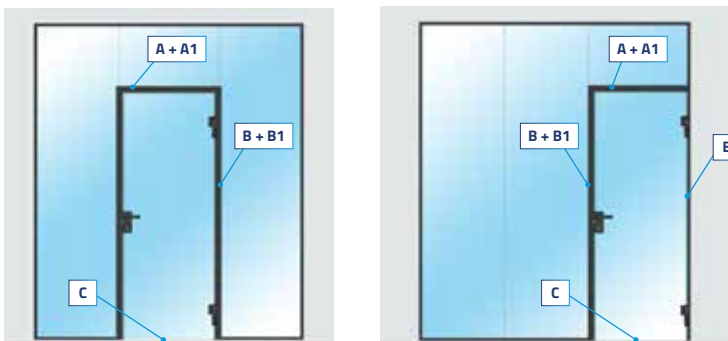

A KIT traverso V-M

KIT architrave

art. **P35E60/14**
(L = 1447 mm)



A1 KIT traverso V-V

KIT architrave

art. **P35E61/14**
(L = 1447 mm)

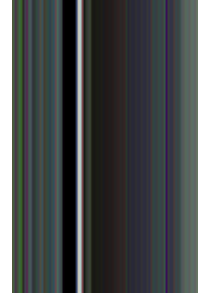

B KIT montante V-M

KIT jamb

art. **P35E60/29**
(L = 2898,5 mm)



B1 KIT montante V-V

KIT jamb

art. **P35E61/29**
(L = 2898,5 mm)



C Profilo isolante

Insulating profile

art. **1460GD** p. 36



0° -90° SOLO A TIRARE ONLY TO PULL

CERNIERE OLEODINAMICHE - OILDYNAMIC HINGES

Biloba Evo

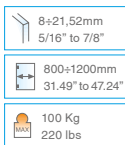

K8835E + 835E10N

Biloba

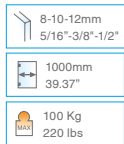

8060P1

CERNIERE LIBERE - FREE HINGES

Collio

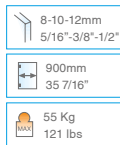
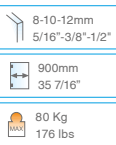

K8680 + 8680

8665P1

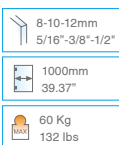

8674P1

SERRATURE vetro / montante

LOCKS glass / jamb

FLEXA series



FLEXA series + OP35E1

LOQ series



LOQ series + OP35E2

MAGNETIC LOQ series



MAGNETIC LOQ series + OP35E5

VERTICALE



622E10R/L + OP35E3



620E10R/L + OP35E4

Fluido+ system

Porte scorrevoli

Sliding doors



FLUIDO+ 70
art. **KB070** - kit

FLUIDO+ 110
art. **KB110** - kit

FLUIDO+ 150
art. **KB110** - kit



Fluido+ 70, 110 e 150 sono i nuovi sistemi scorrevoli compatti per porte in vetro temperato. Le pareti buie appartengono al passato, le esigenze di oggi sono trasparenza e spazi ampi. La meccanica indistruttibile dei sistemi Fluido+ si fonde perfettamente con il design moderno, garantendo sicurezza, privacy e luminosità.

Progettato per soddisfare le richieste del mercato, è adatto per applicazioni: a muro, a soffitto e falso soffitto. Nella versione a falso soffitto il meccanismo è completamente nascosto.

Fluido+ integra il nuovo sistema Colcom di chiusura progressiva “Colcom Progressive Closing System”(CPCS); è l'accessorio che permette una chiusura automatica e graduale della porta.

Il sistema antishock integrato rallenta la corsa della porta nell'ultimo tratto di chiusura, evitando situazioni di pericolo.

Fluido+ 70, 110 and 150 are our latest compact sliding systems for tempered glass doors. Dark walls belong to the past: modern needs are clarity and ample spaces. The resistant mechanics of Fluido+ systems blends perfectly with their modern design, allowing security, privacy and brightness. Conceived to respond market needs, they are suitable for wall, ceiling and false ceiling installations. In the false ceiling version, the sliding mechanism is completely hidden.

Fluido+ features the new closing system “Colcom Progressive Closing System” (CPCS); accessory allows an automatic and gradual closing of the door. The integrated antishock system slows the movement of the door in the last section, avoiding dangerous situation.



Porte scorrevoli con sopraluce

Sliding doors with transom

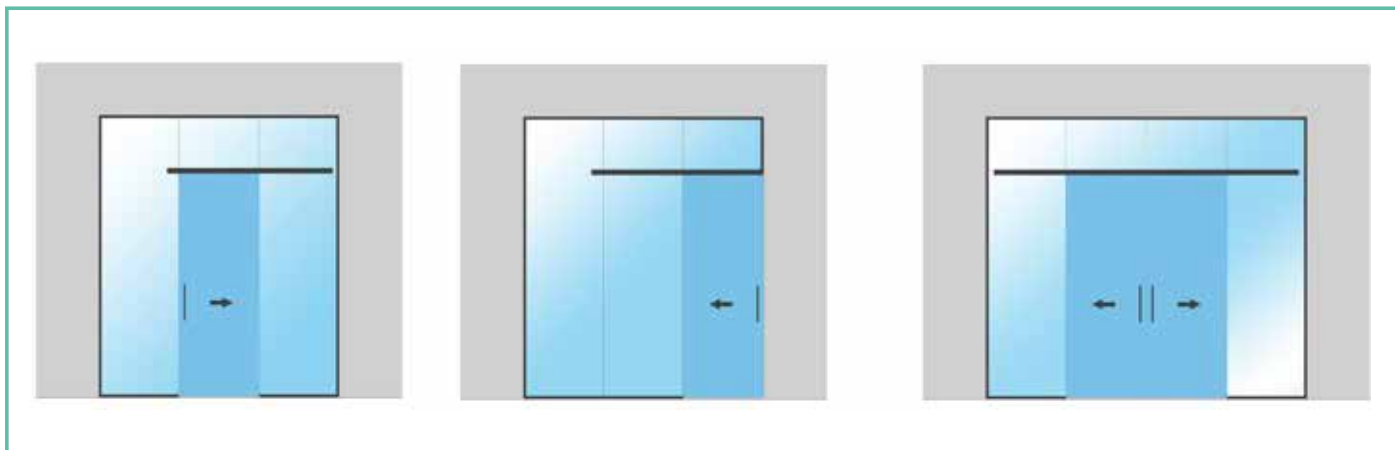

FLUIDO+ 70

(L = 2, 3, 4 e 6 metri)

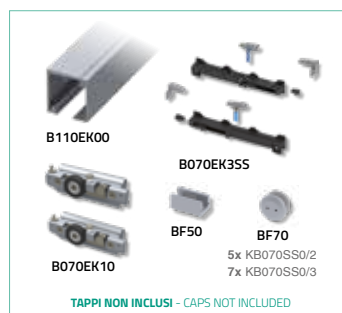
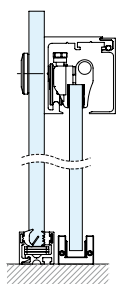
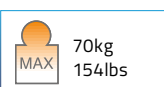
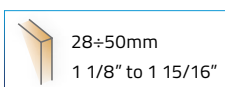
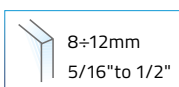

FLUIDO+ 110

(L = 2, 3, 4 e 6 metri)

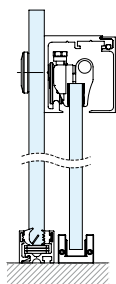
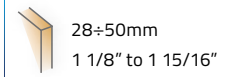
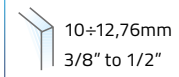

FLUIDO+ 150

(L = 2, 3, 4 e 6 metri)

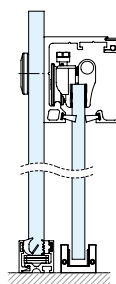
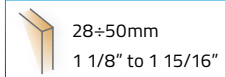
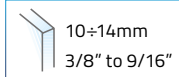

Porte scorrevoli a tutta altezza

Full-height sliding doors

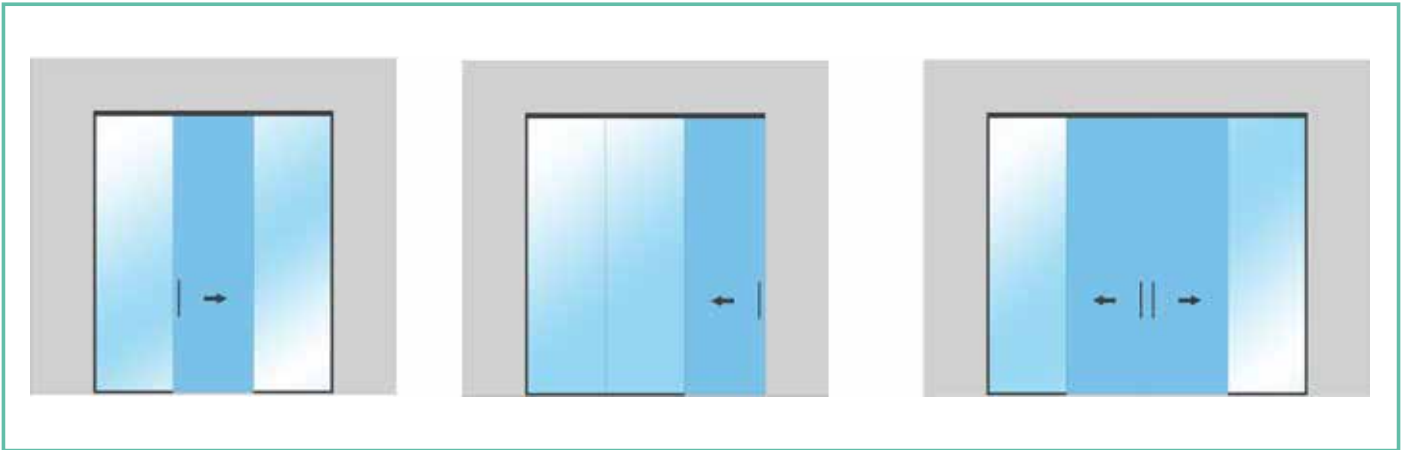

FLUIDO+ 70

(L = 2, 3, 4 e 6 metri)

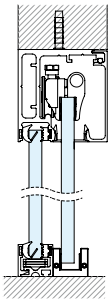
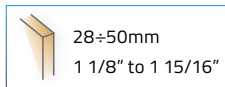
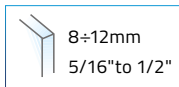

KB070FM0/2 KB070FM0/3

- Kit scorrevole a soffitto con fisso, con retainer e stop meccanico.

- Sliding ceiling kit with fixed, with retainer and mechanical stop

TAPPI NON INCLUSI - CAPS NOT INCLUDED



KB070FS0/2 KB070FS0/3

- Kit scorrevole a soffitto con fisso, con doppio soft-close.

- Sliding ceiling kit with fixed, with double soft-close

TAPPI NON INCLUSI - CAPS NOT INCLUDED

FLUIDO+ 110

(L = 2, 3, 4 e 6 metri)

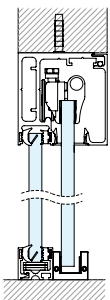
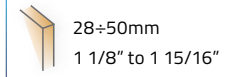
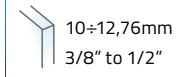

KB110FM0/2 KB110FM0/3

- Kit scorrevole a soffitto con fisso, con retainer e stop meccanico.

- Sliding ceiling kit with fixed, with retainer and mechanical stop

TAPPI NON INCLUSI - CAPS NOT INCLUDED



KB110FA0/2 KB110FA0/3

- Kit scorrevole a soffitto con fisso, con retainer e antishock.

- Sliding ceiling kit with fixed, with retainer and Antishock.

TAPPI NON INCLUSI - CAPS NOT INCLUDED

FLUIDO+ 150

(L = 2, 3, 4 e 6 metri)

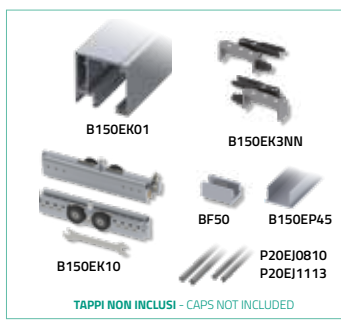
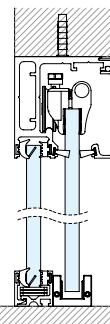
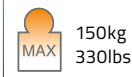
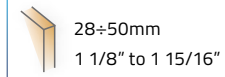
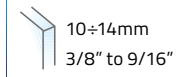

KB150FM0/3.2

- Kit scorrevole a soffitto con fisso, con retainer e stop meccanico.

- Sliding ceiling kit with fixed, with retainer and mechanical stop

TAPPI NON INCLUSI - CAPS NOT INCLUDED

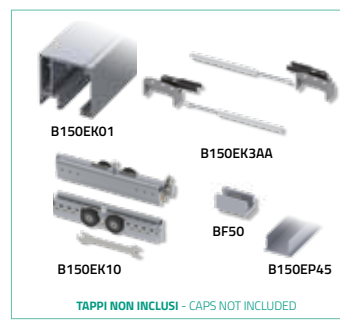

KB150FA0/3.2

- Kit scorrevole a soffitto con fisso, con retainer e antishock.

- Sliding ceiling kit with fixed, with retainer and Antishock.





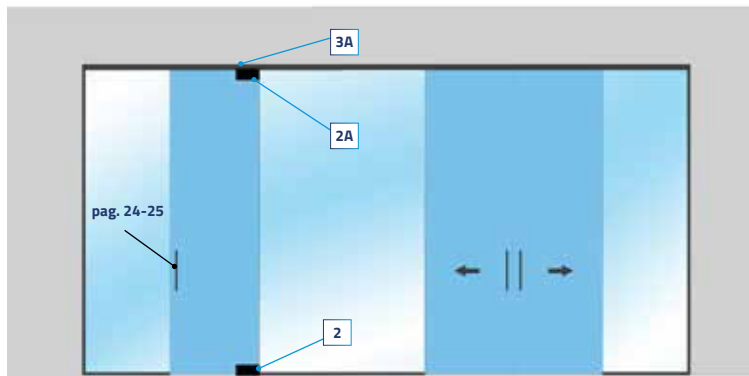



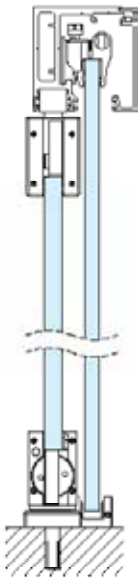







TAPPI NON INCLUSI - CAPS NOT INCLUDED

Porta con cerniere pivot in angolo integrata al profilo Fluido+ Door with pivot corner hinges integrated in Fluido+ profile



FLUIDO+ 70, 110 e 150 (L = 2, 3, 4 e 6 metri)







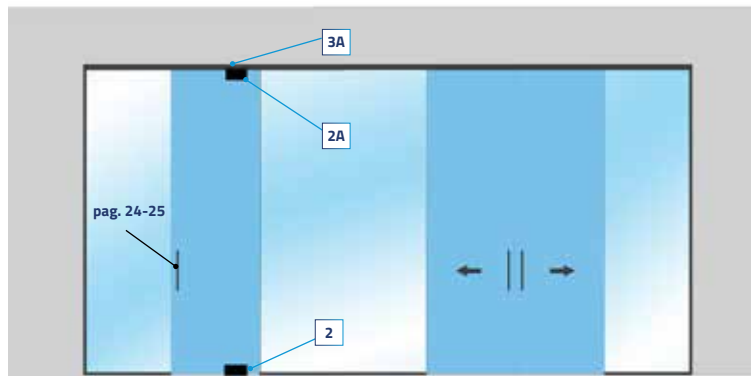



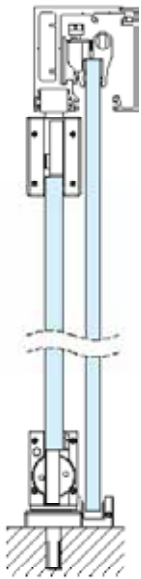

CERNIERE PIVOT A BILICO PIVOT HINGES		PILETTA SOFFITTO TOP PIVOT	
2	2A	3A	
CERNIERE OLEODINAMICHE - OILDYNAMIC HINGES			
Biloba Unica  101E10 8+13,52mm 5/16" to 1/2" 1000mm 39.37" 100 Kg 220 lbs	 100E20 8+13,52mm 5/16" to 1/2" 1000mm 39.37" 100 Kg 220 lbs	 1020 10-12 3/8"-1/2" 1000mm 39.37" 66 Kg 145 lbs	 B150EP27
Biloba Unica NF  101E10NF 8+13,52mm 5/16" to 1/2" 1000mm 39.37" 100 Kg 220 lbs	 100E20 8+13,52mm 5/16" to 1/2" 1000mm 39.37" 100 Kg 220 lbs	 1020 10-12 3/8"-1/2" 1000mm 39.37" 66 Kg 145 lbs	 B150EP27
 1010 + CHD1 10-12 3/8"-1/2" 1000mm 39.37" 66 Kg 145 lbs	 1020 10-12 3/8"-1/2" 1000mm 39.37" 66 Kg 145 lbs	 1020 10-12 3/8"-1/2" 1000mm 39.37" 66 Kg 145 lbs	 B150EP27
CERNIERE LIBERE - FREE HINGES			
 1010 + 1730 10-12 3/8"-1/2" 1000mm 39.37" 66 Kg 145 lbs	 1020 10-12 3/8"-1/2" 1000mm 39.37" 66 Kg 145 lbs	 1020 10-12 3/8"-1/2" 1000mm 39.37" 66 Kg 145 lbs	 B150EP27

Porta con cerniere pivot a bilico integrata al profilo Fluido+ Door with pivot hinges integrated in Fluido+ profile



FLUIDO+ 70, 110 e 150 (L = 2, 3, 4 e 6 metri)



CERNIERE PIVOT A BILICO PIVOT HINGES		PILETTA SOFFITTO TOP PIVOT
2	2A	3A
CERNIERE OLEODINAMICHE - OILDYNAMIC HINGES		
Biloba Unica  101E10 8+13,52mm 5/16" to 1/2" 1000mm 39.37" 100 Kg 220 lbs	 100E20 8+13,52mm 5/16" to 1/2" 1000mm 39.37" 100 Kg 220 lbs	 B150EP27
Biloba Unica NF  101E10NF 8+13,52mm 5/16" to 1/2" 1000mm 39.37" 100 Kg 220 lbs		
 1810 + CHD1 10-12mm 3/8"-1/2" 1200mm 47.24" 80 Kg 1476 lbs	 1820 10-12mm 3/8"-1/2" 1200mm 47.24" 80 Kg 1476 lbs	
CERNIERE LIBERE - FREE HINGES		
 1810 + 1730 10-12mm 3/8"-1/2" 1200mm 47.24" 80 Kg 1476 lbs	 1820 10-12mm 3/8"-1/2" 1200mm 47.24" 80 Kg 1476 lbs	 B150EP27



Trasparenza e privacy

Transparency and privacy

Uno dei concetti alla base delle pareti divisorie è il raggiungimento della massima trasparenza. Questo è possibile grazie agli speciali profili adesivi in policarbonato trasparente che vengono posizionati tra due lastre di vetro adiacenti. Continuità visiva, flusso luminoso e percezione degli ambienti in questo modo non vengono minimamente ostacolati, conferendo agli ambienti un'atmosfera di assoluta pulizia e luminosità.

Soluzioni ideali nel caso di edifici dotati di grandi profondità, dove c'è bisogno di far penetrare la luce naturale, o nel caso si desideri creare ambienti interni "aperti" allo sguardo.

One of the concepts of a partition wall is the achievement of maximum transparency. This is possible thanks to special adhesive profiles in transparent polycarbonate, which are positioned between two adjacent sheets of glass. As a result, visual continuity, luminous flux and indoor perception are barely impacted, creating rooms with a sharp, clean and bright look.

This is an ideal solution in buildings with considerable depth requiring the entry of natural light, or when designing indoor settings with an open look.



JOINT

Profili guarnizione

Glass dry joints



"I" Joint



PCC14/3



"H" Section



PCC18/3



Abutment Joint



PCC12/3



Square Corner Joint



PCC13/3



Flexible "I" Joint



Side Seal



Minimal Corner Joint



Top & Bottom Seal

I profili guarnizione JOINT sono la soluzione ideale per unire pareti divisorie interne in vetro. Garantiscono una finitura elegante e minimale delle pareti in vetro. Sono un'alternativa al silicone, la loro installazione è rapida e facile perché utilizza un nastro adesivo integrale ad alta adesione, eliminando lo sporco e lo spreco che il silicone può generare. Sono disponibili nelle versioni nera e trasparente e in una ampia gamma di altri colori (come RAL, BS e Pantone).

Glass dry joints offer the ideal solution for joining slimline internal glass partitions, providing a sleek and minimal finish to enhance the overall aesthetics of your glass partition. Providing a suitable alternative to silicone JOINT minimise on-site time with quick, easy installation using integral high bond adhesive tape, whilst removing the mess and waste that sealants can create. They are available in clear and black, as well as a wide range of other colours (according to RAL, BS and Pantone standards)



Guarnizioni porte vetro

Glass door seals

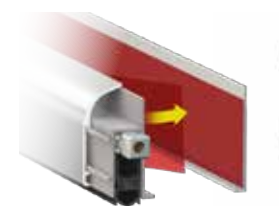

1460GD

- Profilo isolante in lega di alluminio anodizzato o verniciato, per porte in vetro. Completo di guarnizione tubolare in EPDM.
- Aluminium alloy isolating profile, anodized or coated, for glass doors. With EPDM tubular gasket.



1122501 (25 x 1.5mm)

1124101 (25 x 3.0mm)

- Pellicole adesive nere, per applicazioni su partizioni in vetro, in verticale e orizzontale. Adatte per applicazioni successive all'installazione. Facile da rimuovere
- Black adhesive bands, to be applied to glass partitions, both vertically and horizontally. Suitable for application after installation, and easy to remove.

Le guarnizioni per porte in vetro JOINT rappresentano la soluzione ideale per sigillare perimetri e soglie delle porte in vetro. Il sistema porte è stato progettato ad integrazione della gamma di profili guarnizione. La finitura elegante e minimale è assicurata così come la continuità estetica delle pareti in vetro. La gamma comprende anche un profilo isolante automatico. Disponibile in alluminio naturale e nero, questo profilo è il tocco finale alle porte in vetro con e senza frame.

JOINT glass door seals provide an ideal solution for perimeter and threshold sealing of glass doors. The door system has been designed to work in conjunction with the dry joint range to provide a sleek and minimal finish to enhance the overall aesthetics of fully glazed partitions. The range also includes an automatic isolating profile. It is available in natural anodized and black aluminium, and gives the final touch to glass doors, both framed and frameless.



Glass Wall

Paredes de vidrio y accesorios

Organizar el espacio interior

Para organizar el espacio interior se deben tener en cuenta numerosos factores: físicos, ergonómicos, perceptuales y estéticos. Debemos tener en cuenta la evolución de las tendencias en el mundo de la decoración, especialmente en un contexto en constante evolución como es el de las oficinas.

En un escenario tan amplio, los tabiques desempeñan un papel fundamental: se trata de un elemento técnico que ha visto crecer su valor de forma exponencial a lo largo de los años, pasando de simple sistema de separación a verdadero elemento de decoración dotado de todas las prestaciones necesarias para realizar un entorno de trabajo funcional y cómodo.

Nuestras múltiples soluciones pueden satisfacer las más diversas necesidades de instalación.

Glass Wall

Parois vitrées et accessoires

Organiser l'espace intérieur

Pour organiser l'espace intérieur, de nombreux facteurs doivent être pris en compte : physiques, ergonomiques, perceptuels et esthétiques. Il faut s'aligner sur l'évolution des tendances du monde de la décoration, d'autant plus dans un contexte en constante évolution comme celui des bureaux.

Dans un scénario aussi vaste, les cloisons de séparation jouent un rôle fondamental : il s'agit en effet d'un élément technique qui a vu augmenter sa valeur de manière exponentielle au fil des ans, passant d'un simple système de séparation à un véritable élément de décoration équipé de toutes les caractéristiques nécessaires pour rendre un environnement de travail fonctionnel et confortable.

Nos multiples solutions sont en mesure de satisfaire les besoins d'installation les plus divers.

Glass Wall

Neue Serie Duschtürpendelbänder

Innenräume gestalten

Bei der Gestaltung von Innenräumen müssen viele Faktoren wie z. B. physische, ergonomische, perzeptorische und optische Faktoren berücksichtigt werden. Man muss sich den wechselnden Trends im Universum der Inneneinrichtung anpassen, vor allem dann, wenn es sich ständig weiterentwickelt wie im Büro.

Eine grundlegende Rolle spielen in einem solch großen Szenario die Trennwände. Hierbei handelt es sich um ein technisches Element, das im Laufe der Jahre seine Bedeutung exponentiell steigern konnte und sich von einem einfachen Trennwandsystem zu einem wahren Einrichtungselement entwickelt hat, dessen Eigenschaften das Arbeitsumfeld funktionell und komfortabel gestalten.

Unsere vielfältigen Lösungen werden zahlreichen Installationsanforderungen gerecht.



Colcom Group Srl

Tel. (+39)0302532008 - (+39)0302530289

Fax. (+39)0302534707

colcomgroup.it

Via degli Artigiani, n° 56 int.1 - 25075 Nave (Brescia) - Italy

Member of the

**SIMONSWERK
GROUP**