

AXIM c88 UNIVERSAL CONCEALED TRANSOM CLOSER

▲ The AXIM SERIES 8800 has been developed to provide the door control market with a truly universal door closer. We offer the answer to many of the problems the industry is asked to solve by the increasingly aware client.

▲ APPLICATIONS:
 Double or Single Action.
 Centre Hung/Side Load.
 70mm Standard Pivot Point.
 65mm Glass Door
 Finger Guard/Timber Door.

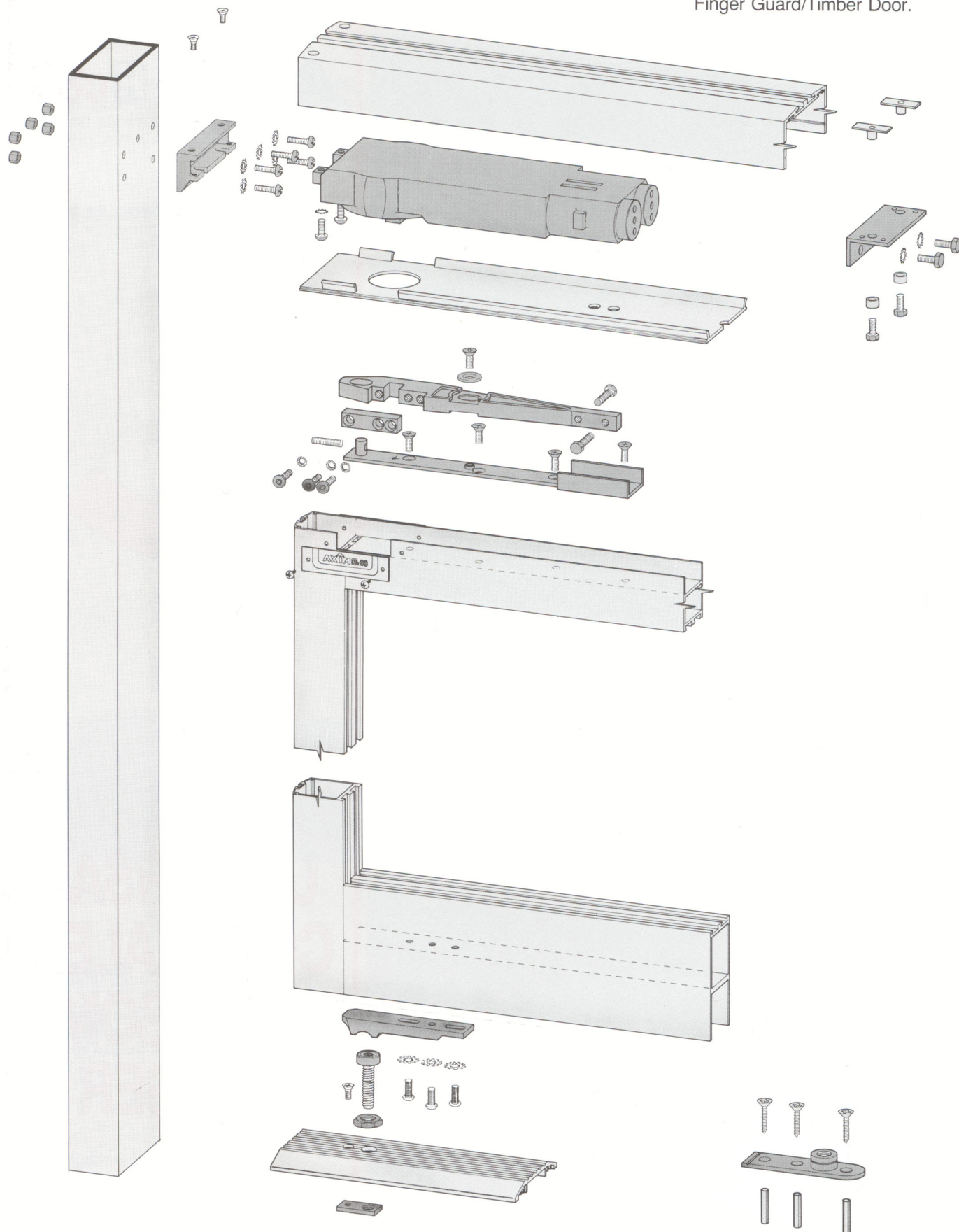

TECHNICAL INFORMATION

▲ Closer units available in three strengths.

▲ Control options NO HOLD, HOLD OPEN 90° & HOLD OPEN 105°.

▲ 130° Backcheck.

▲ Compact size.

▲ Closing & Latching control valves.

▲ Self-adhesive labels 'DO NOT DRILL THIS AREA'

▲ Installation Guide with drilling templates.

▲ 65mm Pivot Point fixing bracket, Glass Door.
Product Code 8800-12.

▲ Standard Top Arm and Channel – side load.
Product Code 8800-13.

▲ Fully adjustable, vertically within opening & central parking positions.

▲ Hexagon spanner provided.

▲ Hole and centre lines in channel for easy location of pivot point.

▲ Universal Bottom Pivot.
Product Code 8800-02.

▲ Fully adjustable height 31.5mm to 58.5mm.

▲ 100 kg loading radial bearing.

▲ 70mm Standard Pivot Point.

▲ 65mm Pivot Point, Glass Door, cut on 5mm 'V' groove line.

▲ Threshold & Tie Bar secured threaded backplate.

▲ 1 full turn equals 2mm adjustment.

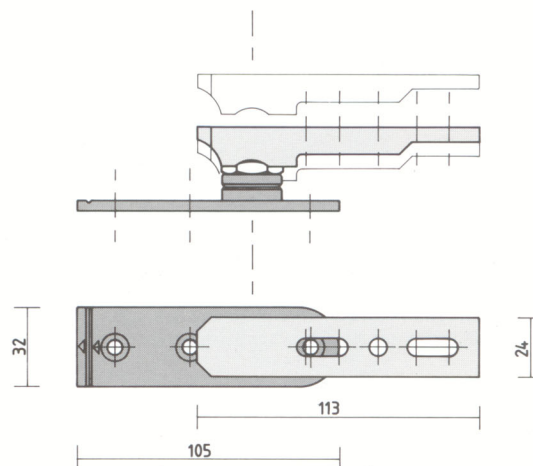
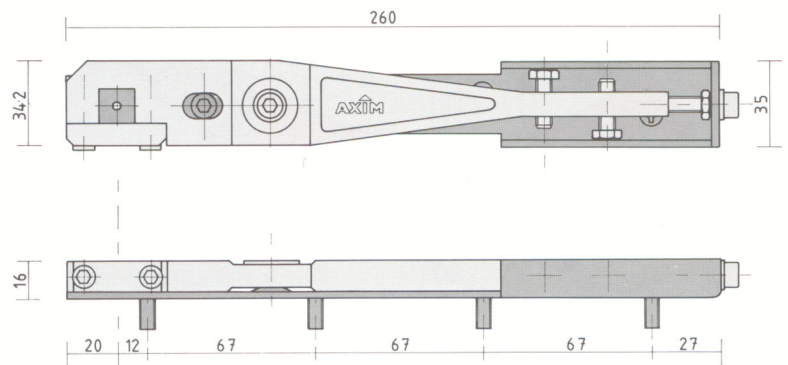
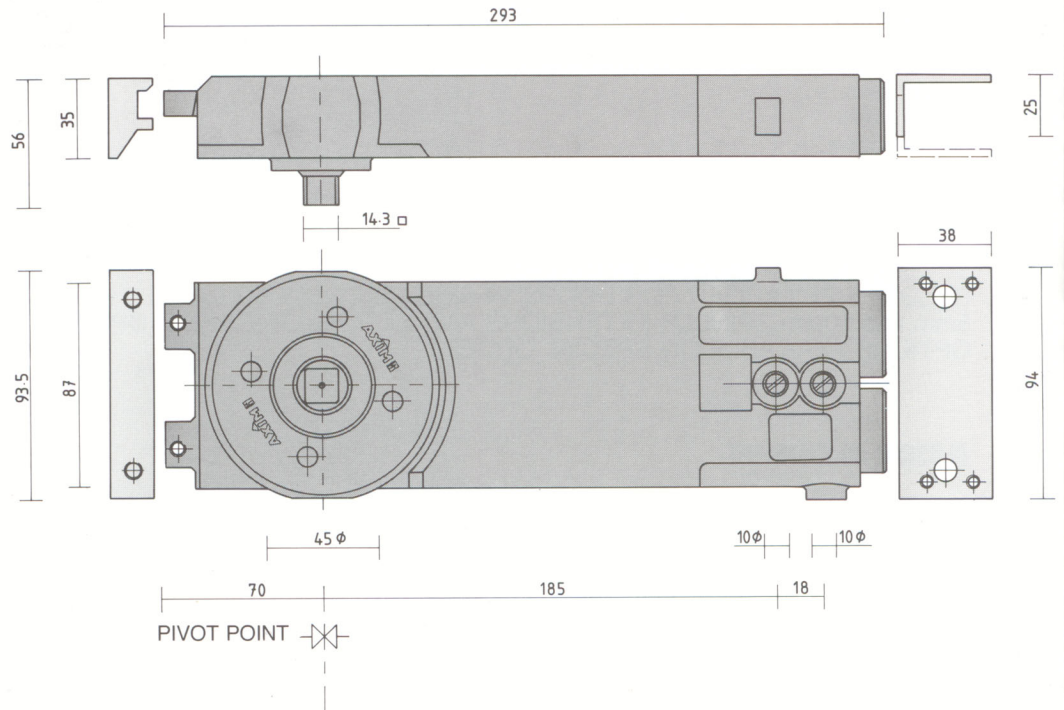

▲ Universal Top Arm and Channel – side load
Product Code 8800-01.

▲ Fully adjustable, vertically within opening & central parking positions.

▲ Hexagon spanner provided.

▲ Hole and centre lines in channel for easy location of pivot point.

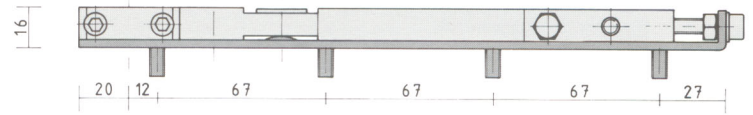
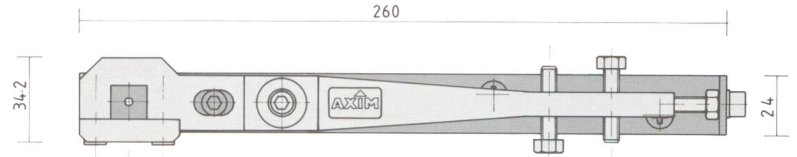

▲ Standard Arm 'T' option.
Product Code 8800-T13.

▲ Offering lateral adjustment through hinge stile.

▲ Fully adjustable as all other arms.

▲ Hole and centre lines in channel for easy location of pivot point.

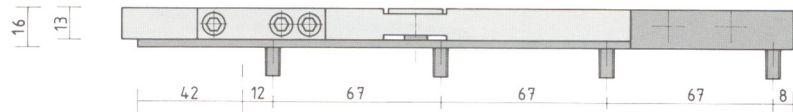
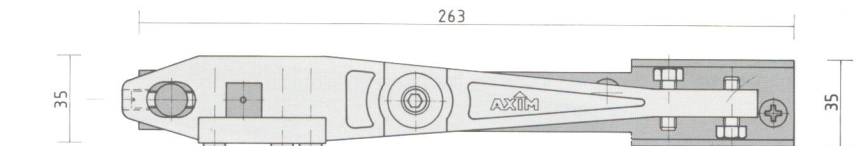

▲ End load Top Arm and Channel.
Product Code 8800-15.

▲ Fully adjustable, vertically within opening and central parking positions.

▲ 5mm spacer bar for deep top rails included.

▲ Hexagon spanner provided.

▲ Hole and centre lines in channel for easy location of pivot point.

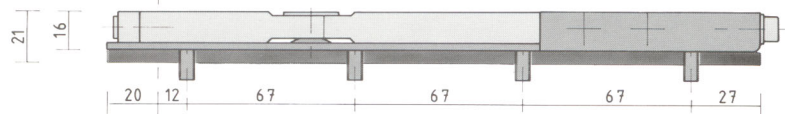
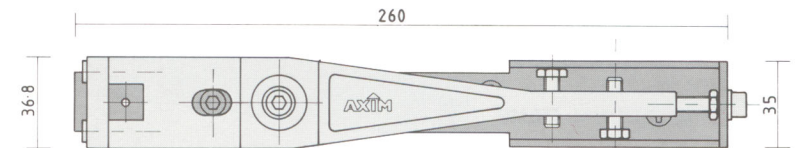

▲ End load Bottom Pivot,
Product Code 8800-14.

▲ Fully adjustable height 31.5mm to 58.5mm.

▲ 100 kg loading radial bearing.

▲ 70mm standard pivot point.







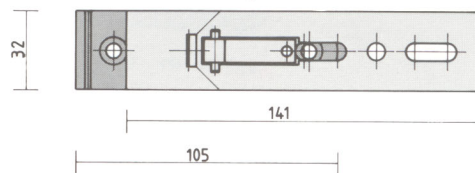
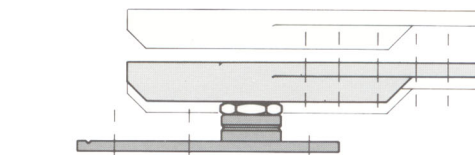

▲ 65mm pivot point glass door. Cut on 5mm 'V' groove line.

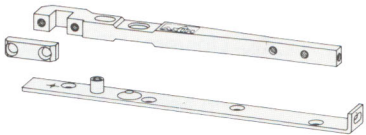
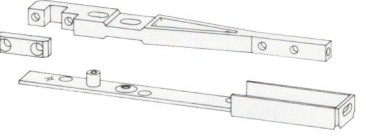
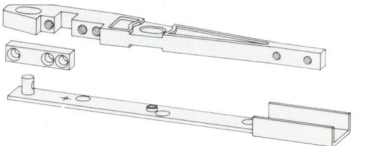
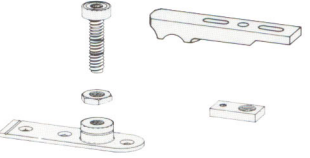
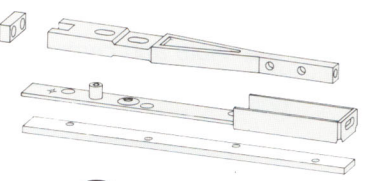
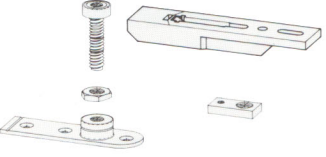
▲ Automatic catch with stainless steel spring.

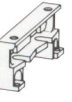
▲ 1 full turn equals 2mm adjustment.

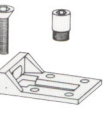

ACCESSORIES

	PRODUCT CODE	WT. Kg.	UNIT	
▲ SIDELOAD				
Universal top arm, including fixings.	8800-01	0.56	EACH (1)	
Standard top arm, including fixings.	8800-13	0.72	EACH (1)	
Standard arm 'T' option, including fixings.	8800-T13	0.68	EACH (1)	
Universal bottom pivot assembly, including fixings.	8800-02	0.21	EACH (1)	
▲ ENDLOAD				
Top arm, including fixings.	8800-15	0.96	EACH (1)	
Bottom pivot assembly, including fixings.	8800-14	0.25	EACH (1)	
▲ ADDITIONAL ITEMS				
65mm pivot point fixing bracket.	8800-12	0.07	EACH (1)	
'A' kit, closing jamb/header bar bracket, including fixings.	8800-03	0.07	EACH (1)	
'B' kit, used with narrow width toughened glass, door rails, including fixings.	8800-04	0.06	EACH (1)	
'C' kit, 5mm shim bar.	8800-05	2.40	TEN (10)	
'D' kit, shallow channel adjuster bracket.	8800-11	-	TEN (10)	
AXIM tag plates (bronze anodised B7).				
Flat	8800-06	0.04	TEN (10)	
Pressed (mill finish for customers own treatment).	8800-07	0.04	TEN (10)	
Flat	8800-08	0.04	TEN (10)	
Pressed	8800-09	0.04	TEN (10)	
AXIM M5/6 cranked spanner, zinc plated.	8800-10	0.38	TEN (10)	

AXIM SERIES 8800 BODY UNIT

DOOR WIDTH	CLOSER SIZE	CLOSING FORCE in Nm (kpm)	NO HOLD	HOLD OPEN 90°	HOLD OPEN 105°
			PRODUCT CODE		
Up to 750mm	1	20 (2:0)	8801-00	8801-90	8801-105
751 to 950mm	2	27 (2:7)	8802-00	8802-90	8802-105
951 to 1150mm	3	33 (3:3)	8803-00	8803-90	8803-105
SHIPPING WEIGHT 4:46KG					

SELECT SIZE SMALLER FOR INTERNAL DOORS.
 SELECT SIZE LARGER FOR DOORS IN SEVERE CONDITIONS.
 5mm and 10mm SPINDLE EXTENSIONS AND ALTERNATIVE HOLD-OPEN
 OPTIONS AVAILABLE ON SPECIAL ORDER.

CLOSING ADJUSTMENT

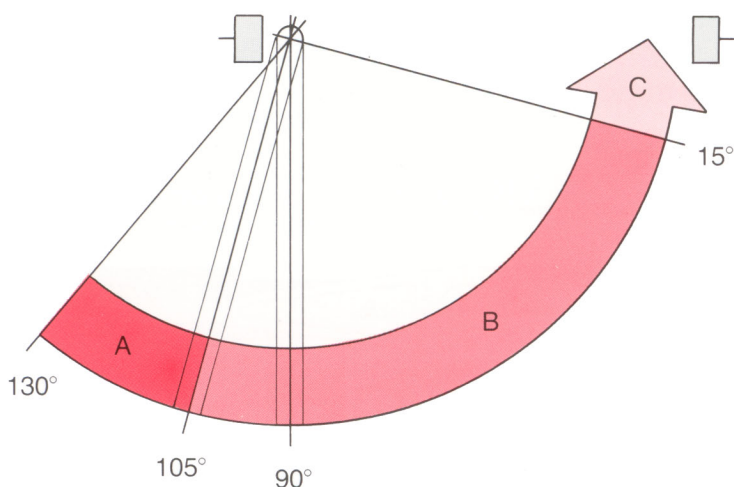

A BACKCHECK

B CLOSING RANGE

C LATCHING RANGE

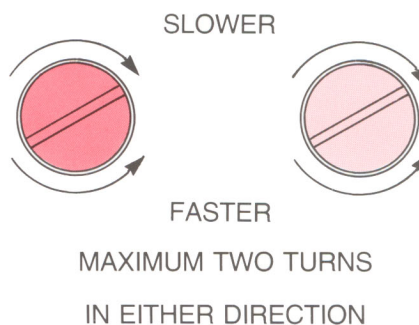
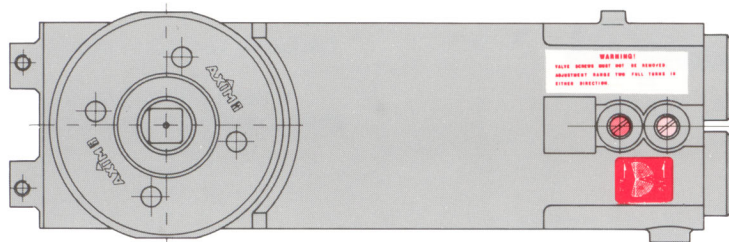

GUARANTEE

AXIM TRANSOM CLOSERS AND ACCESSORIES ARE GUARANTEED FOR 30 MONTHS FROM THE DATE OF MANUFACTURE AGAINST DEFECT IN MATERIAL AND WORKMANSHIP. THIS GUARANTEE IS VOID IF THE PRODUCT HAS BEEN INCORRECTLY INSTALLED OR DAMAGED IN USE. CLAIMS FOR DAMAGE INCURRED OR WORK DONE THEREON WILL NOT BE ACCEPTED.

AXIM RESERVE THE RIGHT TO UPDATE ITS PRODUCT SPECIFICATION WITHOUT PRIOR NOTICE.

FACTORY AUTHORISED AGENT

